

ETSI TR 103 972 V1.1.1 (2023-07)



**DVB-I service delivery over 5G Systems;  
Deployment Guidelines**

**EBU**

---

**Reference**

DTR/JTC-115

---

**Keywords**

5G, 5GMS, broadcast, DASH, DVB, DVB-I, MABR

**ETSI**

650 Route des Lucioles  
F-06921 Sophia Antipolis Cedex - FRANCE

---

Tel.: +33 4 92 94 42 00 Fax: +33 4 93 65 47 16

Siret N° 348 623 562 00017 - APE 7112B  
Association à but non lucratif enregistrée à la  
Sous-Préfecture de Grasse (06) N° w061004871

---

**Important notice**

---

The present document can be downloaded from:

<https://www.etsi.org/standards-search>

The present document may be made available in electronic versions and/or in print. The content of any electronic and/or print versions of the present document shall not be modified without the prior written authorization of ETSI. In case of any existing or perceived difference in contents between such versions and/or in print, the prevailing version of an ETSI deliverable is the one made publicly available in PDF format at [www.etsi.org/deliver](http://www.etsi.org/deliver).

Users of the present document should be aware that the document may be subject to revision or change of status.

Information on the current status of this and other ETSI documents is available at

<https://portal.etsi.org/TB/ETSIDeliverableStatus.aspx>

If you find errors in the present document, please send your comment to one of the following services:

<https://portal.etsi.org/People/CommitteeSupportStaff.aspx>

If you find a security vulnerability in the present document, please report it through our  
Coordinated Vulnerability Disclosure Program:

<https://www.etsi.org/standards/coordinated-vulnerability-disclosure>

---

**Notice of disclaimer & limitation of liability**

---

The information provided in the present deliverable is directed solely to professionals who have the appropriate degree of experience to understand and interpret its content in accordance with generally accepted engineering or other professional standard and applicable regulations.

No recommendation as to products and services or vendors is made or should be implied.

No representation or warranty is made that this deliverable is technically accurate or sufficient or conforms to any law and/or governmental rule and/or regulation and further, no representation or warranty is made of merchantability or fitness for any particular purpose or against infringement of intellectual property rights.

In no event shall ETSI be held liable for loss of profits or any other incidental or consequential damages.

Any software contained in this deliverable is provided "AS IS" with no warranties, express or implied, including but not limited to, the warranties of merchantability, fitness for a particular purpose and non-infringement of intellectual property rights and ETSI shall not be held liable in any event for any damages whatsoever (including, without limitation, damages for loss of profits, business interruption, loss of information, or any other pecuniary loss) arising out of or related to the use of or inability to use the software.

---

**Copyright Notification**

---

No part may be reproduced or utilized in any form or by any means, electronic or mechanical, including photocopying and microfilm except as authorized by written permission of ETSI.

The content of the PDF version shall not be modified without the written authorization of ETSI.

The copyright and the foregoing restriction extend to reproduction in all media.

© ETSI 2023.

© European Broadcasting Union 2023.

All rights reserved.

# Contents

Intellectual Property Rights .....	5
Foreword.....	5
Modal verbs terminology.....	5
Executive summary .....	6
1 Scope .....	7
2 References .....	7
2.1 Normative references .....	7
2.2 Informative references.....	7
3 Definition of terms, symbols and abbreviations.....	9
3.1 Terms.....	9
3.2 Symbols.....	9
3.3 Abbreviations .....	9
4 Introduction on DVB-I over 5G .....	10
4.1 Summary of existing Commercial requirements .....	10
4.1.1 Overview .....	10
4.1.2 Guiding Use Cases.....	11
4.1.3 Technically-oriented Commercial Requirements .....	11
4.1.4 Summary of timeline and procedural requirements .....	12
4.2 DVB technology overview .....	12
4.2.1 DVB codecs and delivery formats .....	12
4.2.2 DVB-I Service discovery.....	13
4.2.3 DVB-MABR.....	15
4.2.4 DVB Native IP.....	17
4.2.4.1 Overview.....	17
4.2.4.2 DVB-NIP signalling information.....	18
4.2.4.3 DVB-NIP system architecture.....	18
4.2.5 DVB-IPTV.....	19
4.2.6 DVB-TA .....	20
4.3 3GPP/5G technology overview .....	20
4.3.1 5G System.....	20
4.3.2 5G Media Streaming.....	22
4.3.2.1 Principles and Architectures.....	22
4.3.2.2 5G Media Streaming - Protocols and APIs .....	24
4.3.2.3 5G Media Streaming - codecs and formats .....	24
4.3.2.4 Deployment opportunities for 5G Media Streaming.....	25
4.3.3 eMBMS and enhanced TV .....	26
4.4 ETSI JTC Broadcast Technology overview .....	27
4.4.1 LTE-based 5G Broadcast.....	27
4.5 5G-MAG Reference Tools overview .....	29
4.5.1 Background.....	29
4.5.2 5G-MAG Reference Tools high-level architecture.....	29
4.5.3 Reference client for LTE-based 5G Broadcast .....	30
4.5.4 Reference client for 5G Media Streaming .....	32
5 DVB-I over 5G Reference architecture.....	32
5.1 High-level architecture .....	32
6 Service scenarios .....	33
6.1 Introduction .....	33
6.2 Standalone DVB-I Service using 5G Broadcast.....	34
6.2.1 Description.....	34
6.2.2 Architecture .....	35
6.2.3 Procedures and call flows .....	36
6.2.3.1 Service provisioning procedure.....	36

6.2.3.2	Service transmission procedure.....	38
6.2.3.3	Service discovery procedure .....	39
6.2.3.4	Service selection procedure.....	41
6.2.3.5	Service reselection procedure.....	43
6.2.4	Identified gaps in existing DVB/3GPP/ETSI specifications.....	43
6.2.5	Alternative scenarios.....	44
6.2.5.1	Introduction.....	44
6.2.5.2	DVB-MABR over 5G Broadcast .....	44
6.2.5.3	DVB-NIP over 5G Broadcast.....	46
6.2.5.4	DVB-IPTV over 5G Broadcast .....	48
6.3	DVB-I Service using 5G Media Streaming.....	49
6.3.1	Description.....	49
6.3.2	Architecture .....	49
6.3.3	Procedures and call flows .....	49
6.3.3.1	Service provisioning procedure.....	49
6.3.3.2	Service discovery procedure .....	51
6.3.3.3	Service selection procedure.....	51
6.3.3.4	Service reselection procedure.....	57
6.3.4	Identified gaps in existing DVB/3GPP/ETSI specifications.....	57
6.4	DVB-I service offerings simultaneously over broadcast and unicast.....	59
6.4.1	Description.....	59
6.4.2	Generic architecture .....	60
6.4.3	DVB-I via unicast and DVB-DASH via 5G Broadcast .....	61
6.4.3.1	Description .....	61
6.4.3.2	Procedures and call flows.....	62
6.4.3.3	Potential extensions to existing specifications .....	63
6.4.4	Hybrid broadcast-unicast service scenarios .....	64
6.4.4.1	Description .....	64
6.4.4.2	Procedures and call flows for Option 1 .....	65
6.4.4.3	Supporting hybrid unicast-broadcast service use cases for option 1 .....	68
6.4.4.3.1	Introduction .....	68
6.4.4.3.2	Service continuity .....	69
6.4.4.3.3	Time-shifted viewing.....	69
6.4.4.3.4	Content or component replacement.....	69
6.4.4.4	Potential extensions to existing specifications .....	70
History	.....	71

---

# Intellectual Property Rights

## Essential patents

IPRs essential or potentially essential to normative deliverables may have been declared to ETSI. The declarations pertaining to these essential IPRs, if any, are publicly available for **ETSI members and non-members**, and can be found in ETSI SR 000 314: "*Intellectual Property Rights (IPRs); Essential, or potentially Essential, IPRs notified to ETSI in respect of ETSI standards*", which is available from the ETSI Secretariat. Latest updates are available on the ETSI Web server (<https://ipr.etsi.org/>).

Pursuant to the ETSI Directives including the ETSI IPR Policy, no investigation regarding the essentiality of IPRs, including IPR searches, has been carried out by ETSI. No guarantee can be given as to the existence of other IPRs not referenced in ETSI SR 000 314 (or the updates on the ETSI Web server) which are, or may be, or may become, essential to the present document.

## Trademarks

The present document may include trademarks and/or tradenames which are asserted and/or registered by their owners. ETSI claims no ownership of these except for any which are indicated as being the property of ETSI, and conveys no right to use or reproduce any trademark and/or tradename. Mention of those trademarks in the present document does not constitute an endorsement by ETSI of products, services or organizations associated with those trademarks.

**DECT™**, **PLUGTESTS™**, **UMTS™** and the ETSI logo are trademarks of ETSI registered for the benefit of its Members. **3GPP™** and **LTE™** are trademarks of ETSI registered for the benefit of its Members and of the 3GPP Organizational Partners. **oneM2M™** logo is a trademark of ETSI registered for the benefit of its Members and of the oneM2M Partners. **GSM®** and the GSM logo are trademarks registered and owned by the GSM Association.

---

# Foreword

This Technical Report (TR) has been produced by Joint Technical Committee (JTC) Broadcast of the European Broadcasting Union (EBU), Comité Européen de Normalisation ELECTrotechnique (CENELEC) and the European Telecommunications Standards Institute (ETSI).

**NOTE:** The EBU/ETSI JTC Broadcast was established in 1990 to co-ordinate the drafting of standards in the specific field of broadcasting and related fields. Since 1995 the JTC Broadcast became a tripartite body by including in the Memorandum of Understanding also CENELEC, which is responsible for the standardization of radio and television receivers. The EBU is a professional association of broadcasting organizations whose work includes the co-ordination of its members' activities in the technical, legal, programme-making and programme-exchange domains. The EBU has active members in about 60 countries in the European broadcasting area; its headquarters is in Geneva.

European Broadcasting Union  
CH-1218 GRAND SACONNEX (Geneva)  
Switzerland  
Tel: +41 22 717 21 11  
Fax: +41 22 717 24 81

---

# Modal verbs terminology

In the present document "**should**", "**should not**", "**may**", "**need not**", "**will**", "**will not**", "**can**" and "**cannot**" are to be interpreted as described in clause 3.2 of the [ETSI Drafting Rules](#) (Verbal forms for the expression of provisions).

"**must**" and "**must not**" are **NOT** allowed in ETSI deliverables except when used in direct citation.

---

## Executive summary

The present document is an informative Technical Report (TR) on DVB-I service delivery over 5G Systems; Deployment Guidelines. It maps the commercial use cases and requirements from the *Commercial Requirements for DVB-I service support over 5G networks and systems* of DVB BlueBook C100 [i.1] into deployment guidelines.

The present document has been produced by common members from the Joint Task Force formed by 5G-MAG and the DVB Project on DVB-I over 5G.

The present document includes high level summaries of DVB-I over 5G commercial requirements, DVB technologies such as DVB-I, DVB Codecs and delivery formats such as DVB-DASH, DVB-MABR and DVB Native IP, 3GPP technologies such as the 5G System, 5G Media Streaming and eMBMS and enhanced TV, ETSI JTC Broadcast Technology such as LTE-Based 5G Broadcast and the 5G-MAG Reference Tools architecture and client.

The present document details a set of service scenarios:

- Standalone DVB-I Service using 5G Broadcast.
- DVB-I Service using 5G Media Streaming.
- DVB-I service offering simultaneously over BC and UC.

A DVB-I over 5G Reference architecture is proposed to support all service scenarios and requirements.

Each scenario includes workflows with guidance in reference to relevant specifications. Gaps identified in existing specifications are identified and are documented as recommended changes to the relevant specifications under the control of DVB, 3GPP or ETSI.

---

# 1 Scope

The present document maps the commercial use cases and requirements from DVB BlueBook C100 [i.1] into deployment guidelines including a reference deployment architecture.

---

## 2 References

### 2.1 Normative references

Normative references are not applicable in the present document.

### 2.2 Informative references

References are either specific (identified by date of publication and/or edition number or version number) or non-specific. For specific references, only the cited version applies. For non-specific references, the latest version of the referenced document (including any amendments) applies.

NOTE: While any hyperlinks included in this clause were valid at the time of publication ETSI cannot guarantee their long term validity.

The following referenced documents are not necessary for the application of the present document but they assist the user with regard to a particular subject area.

- [i.1] DVB BlueBook C100: "Commercial Requirements for DVB-I over 5G", July 2021.
- [i.2] 5G-Media Action Group: "[Blueprints and Architecture](#)".
- [i.3] ETSI TS 123 246: "Universal Mobile Telecommunications System (UMTS); LTE; Multimedia Broadcast/Multicast Service (MBMS); Architecture and functional description (3GPP TS 23.246 Release 16)".
- [i.4] ETSI TS 126 347: "LTE; Multimedia Broadcast/Multicast Service (MBMS); Application Programming Interface and URL (3GPP TS 26.347 Release 16)".
- [i.5] ETSI TS 126 346: "Universal Mobile Telecommunications System (UMTS); LTE; 5G; Multimedia Broadcast/Multicast Service (MBMS); Protocols and codecs (3GPP TS 26.346 Release 16)".
- [i.6] ETSI TS 126 501: "5G; 5G Media Streaming (5GMS); General description and architecture (3GPP TS 26.501 Release 16)".
- [i.7] ETSI TS 126 512: "5G; 5G Media Streaming (5GMS); Protocols (3GPP TS 26.512 Release 16)".
- [i.8] ETSI TS 103 720: "5G Broadcast System for linear TV and radio services; LTE-based 5G terrestrial broadcast system".
- [i.9] ETSI TS 123 501: "5G; System architecture for the 5G System (5GS) (3GPP TS 23.501 Release 16)".
- [i.10] Ericsson mobility report, November 2020.
- [i.11] ETSI TS 126 511: "5G; 5G Media Streaming (5GMS); Profiles, codecs and formats (3GPP TS 26.511 Release 16)".
- [i.12] ETSI TR 136 976 "LTE; Overall description of LTE-based 5G broadcast (3GPP TR 36.976 Release 16)".
- [i.13] ETSI TS 126 348: "LTE; 5G; Northbound Application Programming Interface (API) for Multimedia Broadcast/Multicast Service (MBMS) at the xMB reference point (3GPP TS 26.348 Release 16)".

- [i.14] ETSI TS 129 116: "LTE; 5G; Representational state transfer over xMB reference point between content provider and BM-SC (3GPP TS 29.116 Release 16)".
- [i.15] ETSI TS 136 300: "LTE; Evolved Universal Terrestrial Radio Access (E-UTRA) and Evolved Universal Terrestrial Radio Access Network (E-UTRAN); Overall description; Stage 2 (3GPP TS 36.300 Release 16)".
- [i.16] ETSI TS 136 211: "LTE; Evolved Universal Terrestrial Radio Access (E-UTRA); Physical channels and modulation (3GPP TS 36.211 Release 16)".
- [i.17] ETSI TS 136 331: "LTE; Evolved Universal Terrestrial Radio Access (E-UTRA); Radio Resource Control (RRC); Protocol specification (3GPP TS 36.331 Release 16)".
- [i.18] ISO/IEC 23000-19: "Information Technology Multimedia Application Format (MPEG-A) - Part 19: Common Media Application Format (CMAF) for segmented media".
- [i.19] ISO/IEC 23009-1: "Information technology -- Dynamic adaptive streaming over HTTP (DASH) -- Part 1: Media presentation description and segment formats".
- [i.20] A. Sengupta, A. Rico Alvarino, A. Catovic and L. Casaccia: "Cellular Terrestrial Broadcast-Physical Layer Evolution From 3GPP Release 9 to Release 16," in IEEE Transactions on Broadcasting, vol. 66, no. 2, pp. 459-470, June 2020, doi: 10.1109/TBC.2020.2986922.
- [i.21] ETSI TS 103 770: "Digital Video Broadcasting (DVB); Service Discovery and Programme Metadata for DVB-I".
- [i.22] ETSI TS 103 285: "Digital Video Broadcasting (DVB); MPEG-DASH Profile for Transport of ISO BMFF Based DVB Services over IP Based Networks".
- [i.23] ETSI TS 103 769: "Digital Video Broadcasting (DVB); Adaptive Media Streaming over IP Multicast".
- [i.24] DVB BlueBook A180: "Native IP Broadcasting", February 2022.
- [i.25] ETSI TS 101 154: "Digital Video Broadcasting (DVB); Specification for the use of Video and Audio Coding in Broadcast and Broadband Applications".
- [i.26] ETSI TS 122 101: "Universal Mobile Telecommunications System (UMTS); LTE; Service aspects; Service principles (3GPP TS 22.101 Release 16)".
- [i.27] 3GPP TR 23.746: "Study on System Architecture Enhancements to eMBMS for Television Video Service (Release 16)".
- [i.28] ETSI TS 122 261: "5G; Service requirements for the 5G system (3GPP TS 22.261 Release 16)".
- [i.29] ETSI TS 128 530: "5G; Management and orchestration; Concepts, use cases and requirements (3GPP TS 28.530 Release 16)".
- [i.30] ETSI TS 123 502: "5G; Procedures for the 5G System (5GS) (3GPP TS 23.502 Release 16)".
- [i.31] DVB BlueBook A181: "Adaptive media streaming over IP multicast; Implementation guidelines and worked examples".
- [i.32] ATSC A/331: "Signaling, Delivery, Synchronization, And Error Protection".
- [i.33] ETSI TS 102 034: "Digital Video Broadcasting (DVB); Transport of MPEG-2 TS Based DVB Services over IP Based Networks".
- [i.34] ETSI TS 103 752-1: "Digital Video Broadcasting (DVB); Dynamic substitution of content in linear broadcast; Part 1: Carriage and signalling of placement opportunity information in DVB Transport Streams".
- [i.35] ETSI TR 103 752-2: "DVB-TA Targeted Advertising - Dynamic substitution of content in linear broadcast - Part 2: Interfacing an advert decisioning service and optimal preparation".



- [i.36] ETSI TS 103 736-1: "Hybrid Broadcast Broadband TV; Targeted Advertising; Part 1: Functional requirements".
- [i.37] ETSI TS 103 736-2: "Hybrid Broadcast Broadband TV; Targeted Advertising; Part 2: Non-functional requirements".
- [i.38] DVB BlueBook A178-3: "DVB-TA Targeted Advertising - Dynamic substitution of content in linear broadcast - Part 3: carriage and signalling of placement opportunity information in DVB-DASH".
- [i.39] DASH-IF IOP-5: "Interoperability Points; Part 5: Ad Insertion in DASH".

## 3 Definition of terms, symbols and abbreviations

### 3.1 Terms

Void.

### 3.2 Symbols

Void.

### 3.3 Abbreviations

For the purposes of the present document, the following abbreviations apply:

3GPP	3 <sup>rd</sup> Generation Partnership Project
5G	5 <sup>th</sup> Generation
5G-MAG	5G-Media Action Group
5GMS	5G Media Streaming
5GMSd	5G Media Streaming (downlink)
5GS	5G System
5QI	5G QoS Class Identifier
ABR	Adaptive Bit Rate
AF	Application Function
AL-FEC	Application Layer Forward Error/ErasurE Correction
API	Application Programming Interface
ATSC	Advanced Television Systems Committee
BER	Bit Error Rate
BLER	BLOCK Error Rate
BM-SC	Broadcast–Multicast Service Centre
CDN	Content Delivery Network
CMAF	Common Media Application Format
CoD	Content on Demand
DASH	Dynamic Adaptive Streaming over HTTP
DN	Data Network
DVB	Digital Video Broadcasting
eMBMS	Evolved MBMS
EPC	Evolved Packet Core
EPG	Electronic Programme Guide
ESG	Electronic Service Guide
E-UTRA	Evolved UTRA
E-UTRAN	Evolved UTRAN
FLUTE	File deLivery over Unidirectional Transport
FTA	Free-To-Air
GBR	Guaranteed BitRate
HLS	HTTP Live Streaming
HTTP	HyperText Transport Protocol

HTTPS	HyperText Transport Protocol over TLS
IP	Internet Protocol
ISD	Inter-Site Distance
LTE	Long Term Evolution
MABR	Multicast Adaptive Bit Rate
MBMS	Multimedia Broadcast Multicast Service
MNO	Mobile Network Operator
MPD	Media Presentation Description
PCF	Policy Control Function
PDU	Protocol Data Unit
PLMN	Public Land Mobile Network
QFI	QoS Flow ID
QoE	Quality of Experience
RAN	Radio Access Network
RAT	Radio Access Technology
ROM	Receive-Only Mode
RTP	Real-time Transport Protocol
SFN	Single Frequency Network
SMF	Session Management Function
S-NSSAI	Single-Network Slice Selection Assistance Information
SST	Slice/Service Type
TMGI	Temporary Mobile Group Identity
TOS	Type Of Service
TV	TeleVision
UDP	User Delivery Protocol
UE	User Equipment
UPF	User Plane Function
URL	Uniform Resource Locator
URLLC	Ultra Low Latency Communication
UTRAN	UTRA Network
XML	eXtensible Markup Language

---

## 4 Introduction on DVB-I over 5G

### 4.1 Summary of existing Commercial requirements

#### 4.1.1 Overview

In July 2021, the DVB Project has approved Commercial Requirements for DVB-I service support over 5G networks and systems in DVB BlueBook C100 [i.1]. That document not only provides a set of 70 technical and procedural requirements, but also introduces key elements of 5G networks and systems related to media distribution including 5G Broadcast, 5G Media Streaming and other ongoing activities in 3GPP. In particular, LTE-based 5G Broadcast (as defined in ETSI TS 103 720 [i.8]) provides all functionalities to operate classical TV services, including receive-only, free-to-air and high-power high-tower network infrastructures. The Commercial Requirements were developed based on six guiding use cases, all documented in an annex to DVB BlueBook C100 [i.1].

5G-based technologies promise to enable content and service providers to access mobile devices, typically interfacing with installable apps. 5G-based distribution to other types of receivers, such as moving vehicles, devices connected to roof-top mounted antennas or 5G-based home gateways, is not excluded. A particular benefit of DVB-I services over 5G is the ability to support integrated DVB-I hybrid services, i.e. services for which the basic broadcast distribution is augmented with unicast for extended service coverage, lower distribution costs, improved quality, and additional user experiences.

The Commercial Requirements themselves are structured in technical and procedural aspects. Generally, the requirements ask for specifications to support different Rel-16-based 5G operation modes, namely 5G Broadcast, unicast-based 5G Media Streaming, concurrent delivery of the same service over both modes, and hybrid DVB-I services. In all cases it is expected that the specifications reuse existing DVB technologies to the extent possible and provide commonalities with other IP-based DVB delivery means.

The technically-oriented requirements are clustered in different service-operation phases, namely provisioning, announcement and detection, components, distribution and delivery, quality and monitoring, as well as client-related aspects. While the requirements are extensive and detailed, for example also including security-related aspects, it is expected that many are already covered by the existing DVB-I specification or would only demand minor extensions. This is a benefit of the original DVB-I design to provide a TV service platform independent of the access layer.

Beyond the technically-oriented requirements, DVB BlueBook C100 [i.1] explicitly addresses different aspects related to collaboration:

- 1) First of all, collaboration is a key issue for potentially successful operation of DVB services over 5G, as broadcast service providers and 5G network operators need to collaborate to beneficially use DVB-I functionalities and 5G functionalities for DVB-I service distribution. This aspect is addressed in the requirements by asking the technical group to provide specifications for network and client-side interfaces and APIs to formalize the communication across these two business domains.
- 2) Secondly, the DVB-I over 5G system is expected to align with common industry practices, for example those developed in 3GPP, 5G-MAG or other organizations that contribute to successful deployment of media and TV services over 5G.
- 3) Finally, an important aspect in the development of DVB specifications is the availability of Verification and Validation (V&V) tools. Collaborative efforts with other organizations such as 5G-MAG, 3GPP or DASH-IF are expected to be initiated in order to support reference and interoperability efforts. As an example, the newly established 5G-MAG Reference Tool project may create synergies with V&V tools for DVB-I over 5G.

## 4.1.2 Guiding Use Cases

The Commercial Requirements in DVB BlueBook C100 [i.1] were developed based on use cases provided by DVB members. The use cases are collected in clause 5 of [i.1] as follows:

- Use case 1: DVB-I over 5G Media Streaming.
- Use case 2: 5G Broadcast/Unicast hybrid delivery to handheld devices.
- Use Case 3: 5G Broadcast standalone with Unicast for EPG.
- Use Case 4: 5G Fixed Wireless Access.
- Use case 5: DVB-I Services to vehicle infotainment systems over 5G.
- Use Case 6: DVB-I Hybrid Service over 5G.

Based on these use cases, use case specific Commercial Requirements were extracted. These extracted Commercial Requirements were then used to consolidate the main Commercial Requirements summarized in clause 4.1.3 of the present document. The Commercial Requirements are linked with the use cases which may provide additional background on Commercial Requirements.

## 4.1.3 Technically-oriented Commercial Requirements

The requirements are provided in clause 2 of DVB BlueBook C100 [i.1]. The core technically-oriented Commercial Requirements from clause 2.2 of [i.1] are summarized in as follows, namely the Technical Module is asked to provide:

- Specifications to enable self-contained DVB-I Services to be delivered over a 5G Broadcast System as defined in ETSI TS 103 720 [i.8].
- Specifications to enable self-contained DVB-I Services over a 5G Media Streaming System as defined in ETSI TS 126 501 [i.6].
- Specifications to enable a basic DVB-I service to be delivered over regular unicast and 5G Broadcast and 5G Media Streaming at the same time as independent service instances. Service instances may be provided with different quality (e.g. bit rate, end-to-end latency, channel switch times, etc.).
- Specifications to enable hybrid DVB-I services using 5G Delivery Networks, defined as:
  - a) The DVB-I service is described in a DVB-I service list.

- b) A basic DVB-I service is distributed via 5G Broadcast.
- c) The service is augmented by ordinary unicast or 5G Media Streaming.

The technically-oriented requirements are then further split on specific aspects of the above service operation:

- 2.3 Service Provisioning
- 2.4 Service Announcement and Detection
- 2.5 Service Component
- 2.6 Service Distribution and Delivery
- 2.7 Service Quality and Monitoring
- 2.8 Client-related functionalities.

#### 4.1.4 Summary of timeline and procedural requirements

Beyond the technically-oriented requirements, DVB BlueBook C100 [i.1] also asks that, in the development of the technical solution, the following ought to be considered:

- The DVB-I over 5G System is supported by reusing existing DVB technologies wherever appropriate.
- The DVB-I over 5G System is based on a layered approach in DVB-I, such that functionalities are predominantly access independent and common with other DVB delivery means and are only enhanced for the specific 5G Delivery Networks.
- The technical solution is aligned with industry practices, for example those developed in 3GPP, 5G-MAG or other organizations that indicate that they deploy 5G-based media distribution systems.
- Relevant extensions for the DVB-I reference app are needed in order to enable 5G-based media distribution.
- DVB-I reference services are to be provided for testing distribution of DVB-I service over 5G Delivery Networks.
- Collaborative efforts with other organizations such as 5G-MAG, 3GPP or DASH-IF are encouraged to be initiated in order to support reference and interoperability efforts.

## 4.2 DVB technology overview

### 4.2.1 DVB codecs and delivery formats

ETSI TS 101 154 [i.25] - specifying audio and video codecs for use in broadcasting and broadband applications - is a core element of all DVB solutions. It is a "living" document, regularly updated to take account of new market requirements and technology developments. It provides implementation guidelines and conformance points for the use of audio and video coding utilizing MPEG-2 systems in satellite, cable and terrestrial broadcasting systems and in IP-based networks, and for the use of video coding for adaptive bitrate delivery over IP-based networks.

In addition to Standard and High Definition television, ETSI TS 101 154 [i.25] covers the first and second phase DVB UHD TV specifications (incorporating increased resolution, High Dynamic Range, High Frame Rates and wider colour space) as well as Next Generation Audio systems.

DVB-DASH [i.22] defines the delivery of live and on-demand TV content over IP networks via HTTP adaptive streaming. It builds on MPEG-DASH, which was the first internationally standardized adaptive bit rate HTTP-based streaming solution. The MPEG-DASH specification includes many options; DVB concentrated on profiling MPEG-DASH for those areas which satisfied the core requirements for live and on-demand use cases. The resulting document profiles MPEG-DASH with a few extensions and constraints along with a set of requirements for the MPEG-DASH player in the client.

In 2019, DVB added a Low Latency extension to DVB-DASH. This provides delivery of linear television over DVB-DASH such that the encoder-to-screen latency as well as start-up delay performance can be on par with other DVB distribution solutions without losing the additional functionalities provided by unicast delivery of television services.

## 4.2.2 DVB-I Service discovery

In 2019, the DVB Project started activities for a specification on how consumers can find and watch TV content, no matter over what type of platform the content is delivered and what type of device is used for consumption. Content formats range from linear and live TV to on-demand replays and users are free to watch their preferred content on their preferred devices including smartphones, laptops, TV sets, set top boxes and streaming sticks. For all these scenarios the same content offer is used which facilitates the service deployment and allows easy adaptation when needed.

The DVB-I architecture builds the technical framework for providing and using these features. The architecture is located at the intersection of broadcast television and internet media streaming, offering the possibility for television services to be delivered to internet connected devices. The mechanisms that can be used to find television services delivered through broadband or broadcast mechanisms as well as methods to retrieve electronic programme data for those services are described in detail in ETSI TS 103 770 [i.21].

The components and interfaces of the DVB-I architecture are shown in clause 4.1 of ETSI TS 103 770 [i.21] and their characteristics are summarized in the present document in figure 4.2.2-1 as an introduction to these items. It should be noted that figure 4.2.2-1 shows a functional architecture. For implementation purposes, interfaces can also be combined. Data exchange at these interfaces happen via HTTP API requests, the response is described in XML format in detail in ETSI TS 103 770 [i.21].

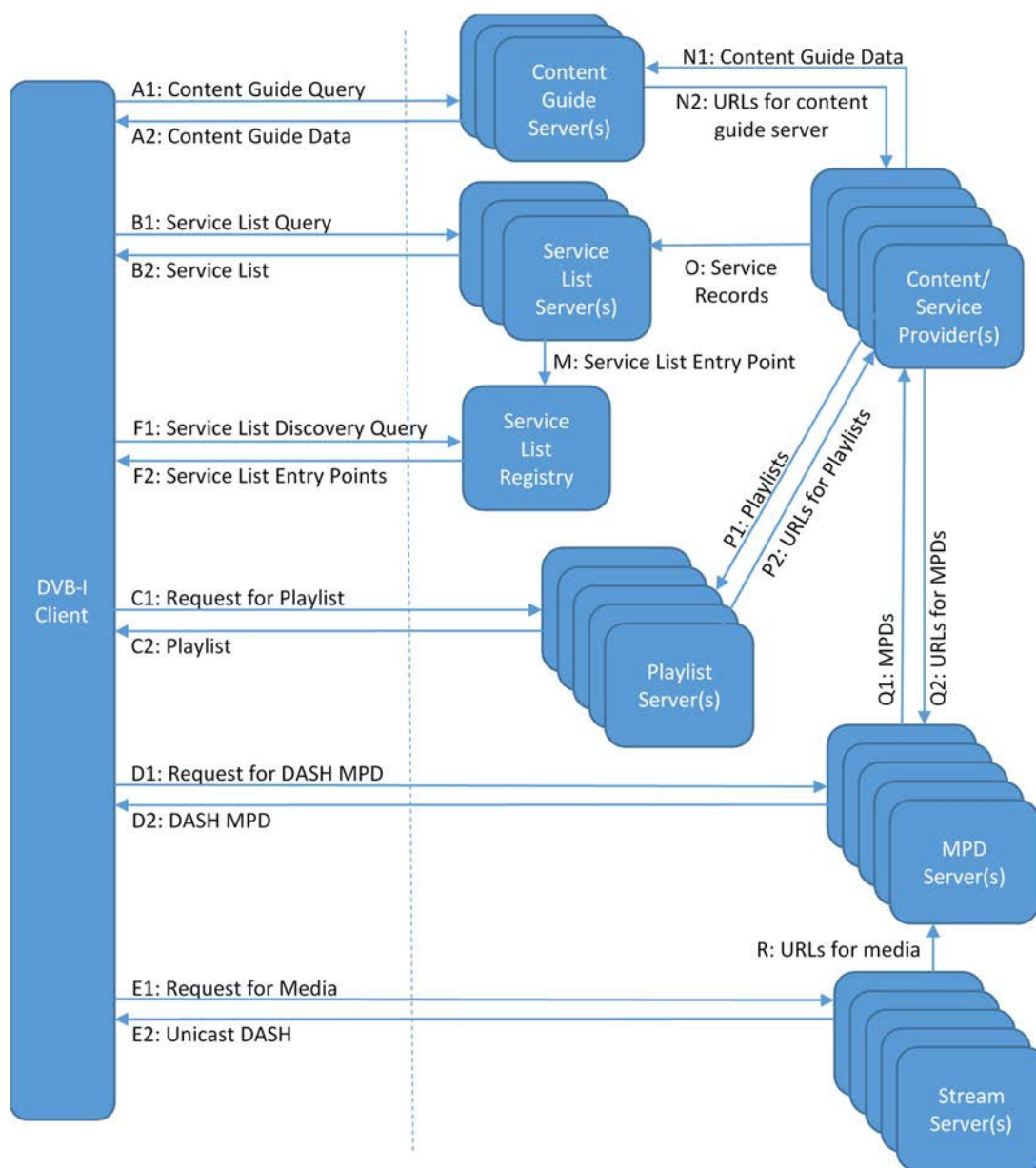

**Figure 4.2.2-1: Basic example of DVB-I components and interfaces**

The interfaces ordered from **A** to **R** follow the workflow of a DVB-I client requesting some content guide data via the selection of an appropriate service up to the delivery of media.

The characteristics of these interfaces are described as follows:

- Interface **A** is used by a DVB-I client to acquire content guide metadata. Any user interaction with a DVB-I service is expected to initiate queries on this interface to retrieve current, future or related programme information.
- Interface **B** is used by a DVB-I client to acquire information about service lists. Depending on the implementation the DVB-I client may offer one or several service lists to the end consumer. This interface is only used to retrieve quasi-static information about a list of services.
- Interface **C** is used by a DVB-I client to ask for the playlist of a service. The provided list can be static but also dynamic, depending on the characteristics of the offered service.
- Interface **D** is used by a DVB-I client to request the Media Presentation Description (MPD) from a media server for the purpose of providing a streaming linear service.

- With the information provided via interface **D** the DVB-I client can request selected media assets via interface **E**.
- Interface **F** is used by the DVB-I client to obtain information for the selection of a service list that fulfils given criteria. Since the number of service lists, or their applicability in a particular scenario, is not expected to change frequently, the use of this interface is anticipated to be low.
- Interfaces **N**, **M**, **O**, **P**, **Q** and **R** are operational interfaces to make service list and content metadata available to clients. These interfaces may re-use formats defined for interfaces A1, A2, B1, B2, C1, C2, D1 and D2.

Details of interfaces **A**, **B**, and **C** can be found in [i.20], while the definition of interfaces **D** and **E** is provided in ETSI TS 103 285 [i.22]. Depending on the deployed scenario, not all the components and interfaces shown in figure 4.2.2-1 may be needed.

### 4.2.3 DVB-MABR

ETSI TS 103 769 [i.23] defines a reference architecture (reproduced in figure 4.2.3-1) in its clause 5 for ingesting media objects, using either a pull- or push-based HTTP mechanism, into a *Multicast server* deployed at a head-end site and transmitting them as a sequence of multicast group-addressed packets over a suitably provisioned IP access network to a population of *Multicast gateway* devices deployed near the end user. This is referred to as reference point **M**.

Each *Multicast gateway* instance subscribes to the multicast group(s) of interest and reconstitutes the original media objects from the multicast packets it receives. It then caches these as playback delivery objects, ready to be requested at reference point **L** by a conventional segmented media player (such as an MPEG DASH client) referred to generically in the architecture as a *Content playback* function.

According to the deployment architectures defined in clause 6 of ETSI TS 103 769 [i.23], the *Multicast gateway* may be deployed in a network edge device, in a home gateway, or co-deployed with the *Content playback* function in an end device such as an integrated television set.

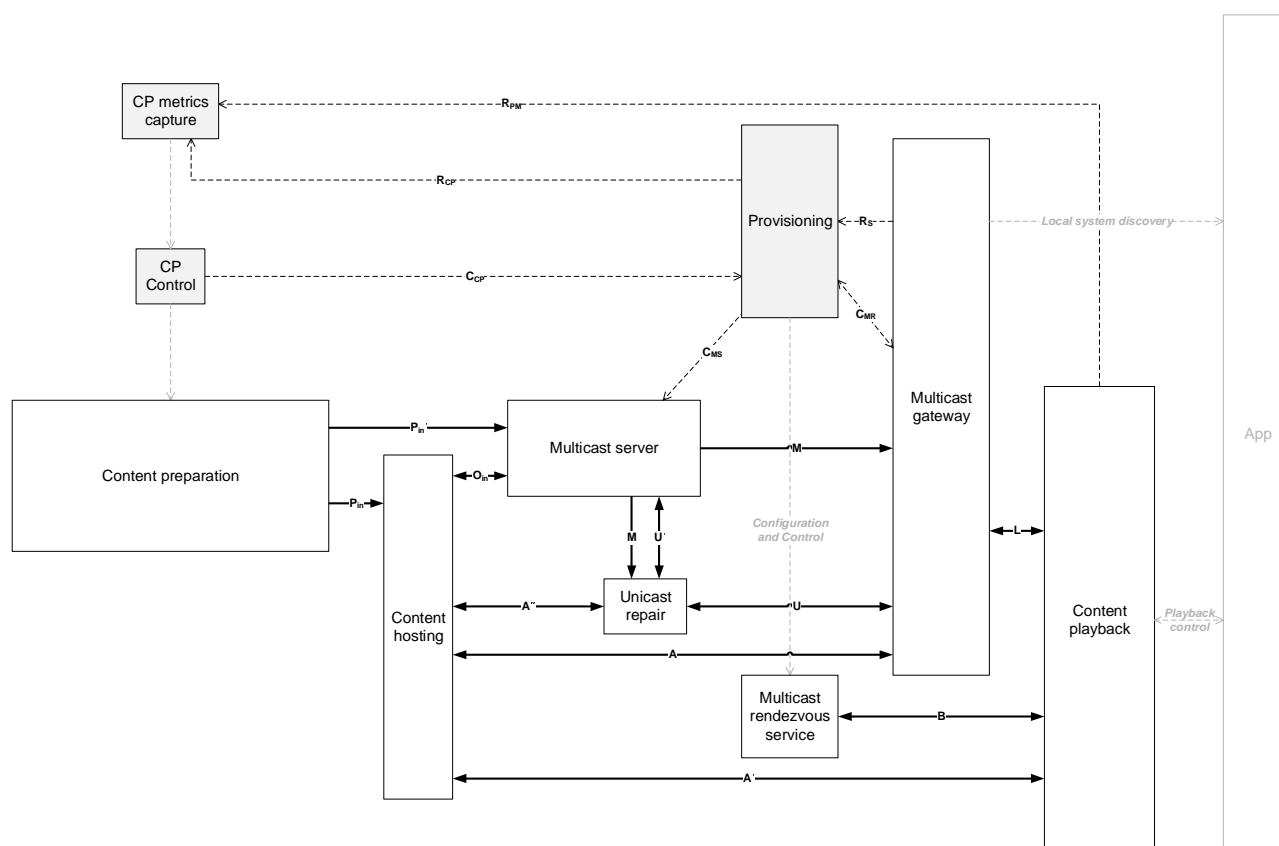

**Figure 4.2.3-1: Simplified reference architecture for DVB-MABR (reproduced from ETSI TS 103 769 [i.23])**

Because multicast IP packets are transported unreliably using UDP, they may be dropped ("erased") by the network during periods of traffic congestion or temporary link interruption. To compensate for this unreliability, the *Multicast server* may be configured to transmit additional redundant Application Layer FEC (AL-FEC) packets via reference point **M**, allowing a proportion of these erased packets to be reconstructed algorithmically by a *Multicast gateway* from the packets that are actually received. If this recovery is unsuccessful (or if AL-FEC information was not transmitted) an HTTP-based unicast repair mechanism may be employed at reference point **A** to recover the missing portion(s) of the affected media object using an efficient byte-range repair. The protocol for this unicast repair mechanism is specified in clause 9.2 of ETSI TS 103 769 [i.23] and the generic procedures are specified in clause 9.1 of ETSI TS 103 769 [i.23].

Clause 4 of ETSI TS 103 769 [i.23] mandates two different *multicast media transport protocols* at reference point **M**; conformant implementations of the *Multicast server* and *Multicast gateway* are required to implement at least one of these protocols:

- A profile of *3GPP FLUTE* is specified in annex F of ETSI TS 103 769 [i.23] based on MBMS Download Profile as specified in clause L.4 of ETSI TS 126 346 [i.5]. A DVB-specific extension specified in clause F.2.2 of ETSI TS 126 346 [i.5] supports a low latency chunked transmission mode in which discrete parts of a media segment (e.g. CMAF chunks) are mapped to FLUTE transport objects.
- A profile of *ATSC ROUTE* based on ATSC A/331 [i.32] is specified in annex H of ETSI TS 103 769 [i.23]. Either ROUTE File Mode or ROUTE Entity Mode may be used. A DVB-specific extension specified in clause H.3.2 of ETSI TS 103 769 [i.23] allows the progressive transmission of media segment chunks using the latter mode, offering the prospect of low-latency transmission of media segments.

NOTE: At the time of writing, this extension supporting low-latency chunk transmission is not available in ATSC A/331 [i.32].

ETSI TS 103 769 [i.23] envisages that additional (optional) multicast media transport protocols may be included in future versions of that specification.

A number of different call flows are specified in clause 7 of ETSI TS 103 769 [i.23]. In particular, clause 7.5 of ETSI TS 103 769 [i.23] specifies how a media streaming session is initiated by a *Content playback* function requesting - via reference point **B** - a presentation manifest from a *Multicast rendezvous service* that is managing a population of *Multicast gateway* instances. If a *Multicast gateway* local to the requesting *Content playback* function is able and willing to handle the session, the *Multicast rendezvous service* redirects the initial request to it and the media streaming session begins at reference point **L**.

The detailed operation of the *Multicast server* is specified in clause 8.3 of ETSI TS 103 769 [i.23] and the corresponding operation of the *Multicast gateway* in clause 8.4 of ETSI TS 103 769 [i.23].

Both the *Multicast server* and the *Multicast gateway* are configured by the *Provisioning* function. An XML schema for representing the current multicast session configuration is defined in annex A of ETSI TS 103 769 [i.23] and the semantics are specified in clause 10 of ETSI TS 103 769 [i.23]. The procedures for configuring a *Multicast server* and a *Multicast gateway* with the current multicast session configuration from the *Provisioning* function using HTTP are specified in clause 10.4 of ETSI TS 103 769 [i.23] where protocols for both pull- and push-based update are specified. In addition, a protocol for transmitting the current multicast session configuration via a service announcement channel at reference point **M** called the *multicast session configuration transport session* is specified in clause 10.4.5 of ETSI TS 103 769 [i.23]. This mode of configuration is especially important in unidirectional deployments where there is no return channel.

The system architecture envisages that the *Multicast gateway* optionally reports data to the *Provisioning* function about the playback sessions it serves. The syntax of the reporting format and the protocol for transmitting it are not yet specified in clause 11 of ETSI TS 103 769 [i.23] but are expected to be published in a future version.

An informative background scenario on DVB-I Service using DVB-MABR can be found in annex A of DVB BlueBook A181 [i.31].



## 4.2.4 DVB Native IP

### 4.2.4.1 Overview

The DVB Native IP specification [i.24] was developed in 2021, based on the commercial requirements of the CM-S group. The scope of that specification covers - with the same broadcast signal - both professional content distribution applications (to CDN caches, mobile or broadcast tower sites, hotspots, planes, ships, etc.) and consumer applications (DTH to IP in-home devices). DVB-NIP Receivers are intended to be able to operate both - in fully connected scenarios where a terrestrial or satellite return channel is available and - in scenarios where they are only connected to the broadcast network. In the latter case, functionality is restricted but sufficient for such use cases.

The DVB-NIP specification defines a new protocol stack for satellite and terrestrial television broadcasting based largely on the use of the Internet Protocol. As illustrated in figure 4.2.4.1-1, DVB-NIP reuses many of the IP standards defined previously by DVB for broadband IP networks and adapts or complements these, only where necessary, for use on DVB broadcast networks.

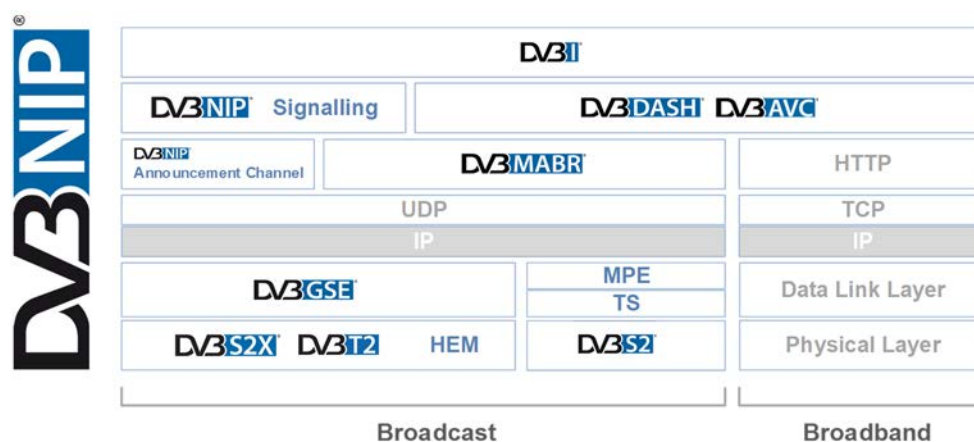

**Figure 4.2.4.1-1: DVB-NIP specification and protocol stack**

DVB Native-IP relies on:

- The DVB-I specification for service discovery and program metadata.
- DVB-DASH and DVB-AVC specifications for AV coding and packaging.
- DVB-MABR for multicast distribution.
- DVB-GSE for link layer adaptation (DVB-MPE for backwards compatibility).
- DVB-S2X and DVB-T2 for physical transport.

Additionally, some DVB-HB functionality is used for in-home distribution scenarios.

In addition to providing usage guidelines for the specifications above, the DVB-NIP specification provides new tools for broadcast receivers to rapidly discover RF channels and services on a broadcast network. Among these tools are:

- A receiver bootstrap mechanism.
- A multicast announcement channel.
- Data structures to inform NIP receivers about the configuration or changes on the broadcast network.

#### 4.2.4.2 DVB-NIP signalling information

DVB-NIP signalling information is carried via a NIP-specified multicast announcement channel. The information carried on this announcement channel is split across six data structures which inform NIP receivers about the technical parameters of the different carriers making up the broadcast network and where DVB-I Service Lists, and AV Services are located on the broadcast network:

- The *Network Information File (NIF)* is an XML instance document that informs receivers about the logical identification of DVB-NIP Streams and their physical carrier parameters. It can be edited by the Technical Operator of the broadcast network providing an overall view of the entirety of a broadcast network or it can be edited by Commercial Operators present on that broadcast network and conveying information only about the Streams part of their own commercial operations. The NIF is carried on one or more so-called network Bootstrap Streams.
- The *Service Information File (SIF)* is an XML instance document that informs receivers about the location of Services across the different DVB-NIP Streams and physical transponders/channels. It can again be edited by the Technical Networks Operator of the broadcast network providing an overall view of the entirety of a broadcast network or it can be edited by Commercial Operators present on that broadcast network and conveying information only about the location of services part of their own operations. The SIF is carried on one or more so-called network Bootstrap Streams.
- The next two data structures are related to the detailed technical operation of the DVB-MABR system [i.23] in the context of DVB-NIP. The *Bootstrap multicast gateway configuration* is an XML instance document conveyed in the announcement channel of each DVB-NIP Stream. It points to the multicast session carrying the *Multicast gateway configuration*, another XML instance document specified in [i.23] that is carried on each NIP Stream and provides the link between service URLs and the IP multicast addresses in use on the broadcast Stream to convey the Services. Both tables are formatted as XML.
- The *DVB-I Service List Entry Points* document lists the DVB-I Service Lists available across the broadcast network. This dedicated broadcast XML document is fully compliant with the DVB-I Service List Entry Points specification in ETSI TS 103 770 [i.21].
- Finally, different *DVB-I Service Lists*, as specified in ETSI TS 103 770 [i.21] may be provided as XML instance documents by the Technical Operator of the network or Commercial Operators present on the network. These list the Services present on the broadcast network and provide the URLs required to access the services.

#### 4.2.4.3 DVB-NIP system architecture

A simplified view of the DVB-NIP architecture is shown in figure 4.2.4.3-1. It consists of the *Native IP Head-end* and the *Native IP Reception* components.

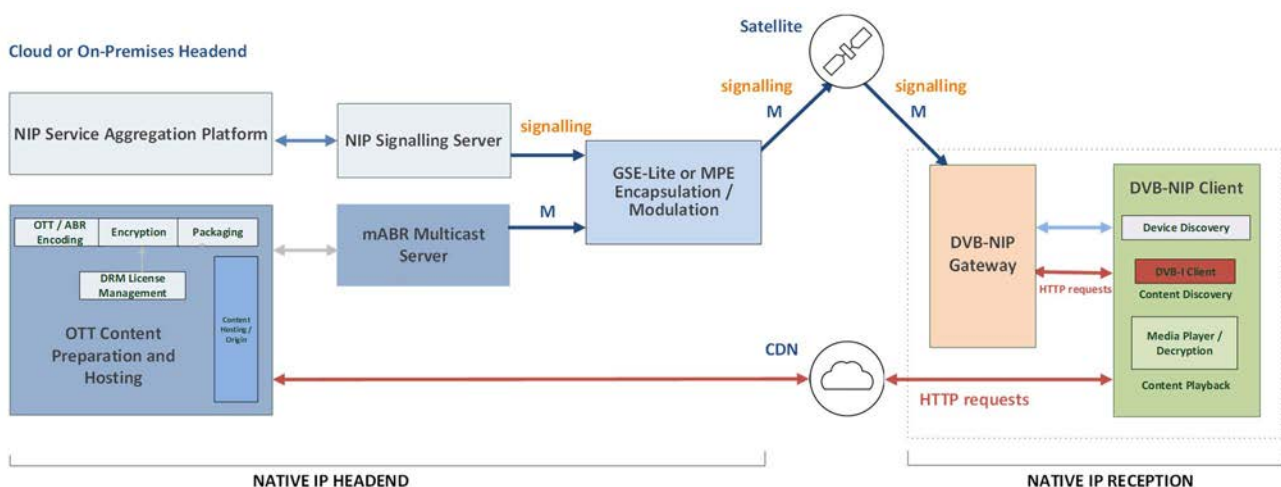

Figure 4.2.4.3-1: DVB-NIP high-level architecture

At the head-end, the main high-level functional blocks of NIP are as follows:

- The *NIP Service Aggregation Platform* is responsible for the compilation of one or more DVB-I Service List(s), the DVB-I Service List Entry Points List, the NIF and SIF, and the DVB-I Content Guide.
- The *OTT Content Preparation and Hosting* platform consists of *Media Encoding*, *Content Encryption*, *Content Packaging* and *Content Hosting* functions. It generally provides the same streams for over-the-top content delivery and, in the case of a DVB-NIP system, also for delivery via Native IP broadcasting.
- The *NIP Signalling Server* builds the multicast signalling channel and carries the DVB-I, NIF, SIF and DVB-MABR signalling information that need to be rapidly acquired by DVB-NIP receivers when tuning to different NIP streams.
- The *Multicast server* is a DVB-MABR function specified in ETSI TS 103 769 [i.23]. It is responsible for generating multicast transport sessions carrying one or more DVB-DASH Services. One Multicast server instance is associated with one logical NIP Stream. The Multicast server retrieves unicast MPEG-DASH services from the OTT content Preparation and Hosting function and provides the services via IP multicast for broadcasting.
- The *Encapsulation and Modulation* function handles the encapsulation of IP multicast datagrams into NIP Streams using DVB-GSE or DVB-MPE and RF signal modulation according to the Physical Layer Specifications described in clause 7.2 of the DVB-NIP specification [i.24].

The DVB-NIP specification describes several receiver architectures based around two logical functions: a *DVB-NIP Gateway* and a *DVB-NIP Client* function:

- The *DVB-NIP Gateway* receives broadcast signals (carrying IP multicast) and makes the content of these available (via IP unicast HTTP) to DVB-NIP Clients.
- The *DVB-NIP Client* presents linear television/radio services to the end-user. The DVB-NIP Client is essentially an off-the-shelf DVB-I Client with an MPEG-DASH player, optional DRM component and device discovery tools from DVB-HB (UPnP and multicast DNS). DVB-NIP Clients interact with the DVB-NIP Gateway via unicast exactly as they interact with Internet CDN servers such as the Content Hosting function.

## 4.2.5 DVB-IPTV

ETSI TS 102 034 [i.33] provides architectures and protocols for the carriage of MPEG-2 TS-based DVB services over multicast-capable IP networks, a system referred to as DVB-IPTV. ETSI TS 102 034 [i.33] is limited to DVB services encapsulated in MPEG-2 TS, covering:

- Live Media Broadcast services (i.e. linear television channels or radio stations).
- Media Broadcast with Trick Modes.
- Content on Demand (CoD) services.
- Content Download Services (CDS).

The DVB-IPTV specification [i.33] defines the mechanisms required in order for a consumer to be able to acquire a standard DVB Home Network End Device (HNED), plug it into an IP network, then choose and consume DVB services available over the IP network. The interface to the HNED, defined as reference point **IPI-1**, represents the end-terminal interface for a DVB-IPTV service.

DVB-IPTV can be used to encapsulate any MPEG-2 Transport Stream compliant with ETSI TS 101 154 [i.25], whether containing single or multiple programs. DVB-IPTV single program services may be described by a service instance in the DVB-I Service List (see clause 4.2.1). For multi-program streams, in-band DVB-SI signalling is typically used instead.

## 4.2.6 DVB-TA

Based on commercial requirements for targeted content insertion approved in June 2018, DVB started technical specification work that completed in 2020 with the following specifications for the dynamic substitution of content in linear broadcast services:

- ETSI TS 103 752-1 [i.34] specifies the carriage and signalling of placement opportunity information in DVB Transport Streams.
- ETSI TR 103 752-2 [i.35] specifies the optimal preparation of dynamically inserted content as well as the interface to a content insertion decision-making service.

In parallel, the HbbTV Specification Working Group has specified functional requirements for targeted content insertion in ETSI TS 103 736-1 [i.36] and non-functional requirements in ETSI TS 103 736-2 [i.37].

Together, this set of DVB and HbbTV specifications represents an initial framework to implement targeted content insertion in the context of MPEG-2 Transport Streams.

In May 2020, DVB started to set out use cases and commercial requirements to extend similar targeted content insertion functionality to DVB-I services delivered via DASH in ways that are optimized for and taking advantage of the characteristics of broadband IP networks. An initial draft is available in DVB BlueBook A178-3 [i.38], but this specification remains incomplete with some significant work still remaining.

From the above specifications and the detailed interoperability guidelines from DASH-IF IOP-5 in [i.39], two main different cases for targeted content insertion need to be differentiated:

- **Server-Side Ad Insertion (SSAI):** In this case, a network entity inserts into or replaces content from the main media stream. The replacement content may be selected to target specific users or based on other targeting parameters. Such a targeting approach is primarily suitable in case of unicast distribution. The the client media player is unaware that content has been substituted.
- **Client-Side Ad Insertion (CSAI):** In this case, the client receives instructions to replace or insert content as part of the main media stream. The selection of replacement content may again be conditioned to specific targeting parameters. The client then acquires targeting content and inserts or replaces the main content for a specified period of time. Implementation of CSAI requires specific provisioning and conditioning of content in particular if only a single decoder and media pipeline is available in the client media player.

A complete architecture for SSAI and CSAI in the context of DVB-I and DVB-DASH similar to the one in DASH-IF IOP-5 [i.39] is not yet available but is considered essential to present a detailed set of deployment guidelines for targeted content insertion when DVB-I is distributed over 5G.

## 4.3 3GPP/5G technology overview

### 4.3.1 5G System

The 5G system architecture as defined in ETSI TS 123 501 [i.9] and shown in figure 4.3.1-1 defines the core of a 5G network and describes the different network functions that build the 5G core.

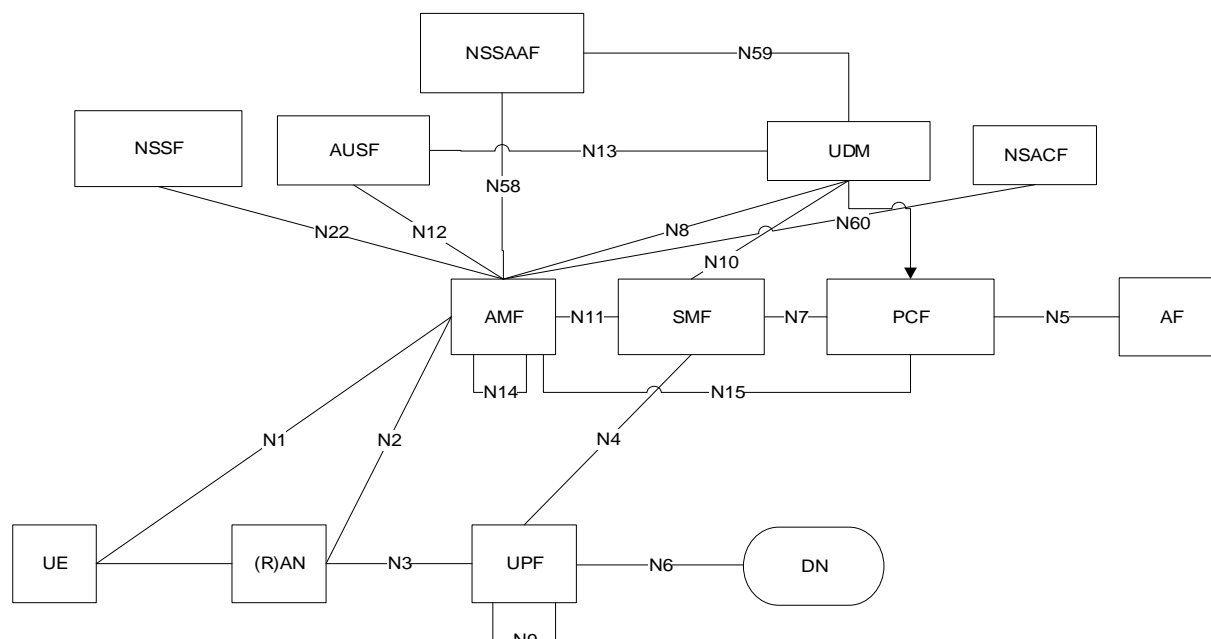

**Figure 4.3.1-1: 5G system architecture (see ETSI TS 123 501 [i.9])**

The following design principles have guided the design of this architecture:

- Separation of user plane from control plane functionality.
- A service-based architecture, where network functions offer services to other network functions and consumers.
- Support for stateless network functions, optimized for speed and large load.
- Scalability through virtualization and distribution, allowing for multiple instances of each network function to be created.

The 5G System (5GS) introduces the concept of network slicing, allowing the creation of dedicated and isolated networking infrastructures that are suited for the service needs. A network slice is a logical network infrastructure identified by a Single-Network Slice Selection Assistance Information (S-NSSAI), which comprises a Slice/Service Type (SST) and a Slice Differentiator (SD). 5GS defines a set of standardized SSTs, one for each service vertical. Media distribution and streaming services may use the enhanced Mobile Broadband (eMBB) slice type. The Ultra-Reliable Low-Latency Communications (URLLC) slice type is also suitable for media services that rely on low-latency communications.

For each specific network slice type, multiple network slice instances may be offered in an operator's 5G network. A network slice instance is selected for a Packet Data Unit (PDU) session by the network from the list of requested and allowed NSSAI(s) and conveyed to the User Equipment (UE) in the PDU session establishment accept message.

The 5G Core network applies Quality-of-Service (QoS) rules on QoS Flows. As part of a PDU session, a QoS Flow is identified by a unique QoS Flow ID (QFI) in the 5G System. All User Plane traffic within a PDU session with the same QFI will receive the same QoS treatment, i.e. traffic forwarding, scheduling, and admission control. All QoS Flows are controlled by the Session Management Function (SMF). A QoS Flow can be pre-configured, established during the PDU session establishment procedure, or by the PDU session modification procedure.

For handling of uplink traffic, the UE follows QoS rules to classify and mark the packets. The QoS rules may be explicitly provided to the UE as part of the PDU session establishment or modification procedures or they may be deduced through reflective QoS.

The SMF assigns a QFI to a QoS Flow and derives its QoS profile and the QoS rules from the policies provided by the Policy Control Function (PCF). The User Plane Function (UPF) then ensures the user plane traffic on the downlink is mapped correctly and the UE performs similar functionality for the uplink traffic.

To identify the traffic, the UPF uses the QoS Flow associated IP Packet Filter Set to match to the correct QoS profile. The Packet Filter Set may include the following parameters:

- Source/destination IP address or IPv6 prefix.
- Source/destination port number.
- Protocol ID of the protocol above IP/Next header type.
- Type Of Service (TOS) (IPv4)/Traffic class (IPv6) and Mask.
- Flow Label (IPv6).
- Packet Filter direction.
- The 5G QoS model supports both Guaranteed Bit Rate (GBR) and non-GBR flows.

A QoS flow is assigned a QoS Profile with some of the following QoS parameters:

- 5G Quality of Service Flow Identifier (5QI): A set of static 5QI characteristics are specified. The characteristics include values that indicate whether it is a GBR or non-GBR QoS flow, the priority level, delay budget, packet error rate and averaging window, and the maximum data burst volume. In addition to the standardized 5QI values, non-standardized 5QI that are tailored to specific services can be defined dynamically.
- Allocation and Retention Priority to indicate the pre-emption priority of the traffic in the QoS flow.
- Guaranteed Flow Bit rate for the uplink and downlink.
- Maximum Flow Bit rate for the uplink and downlink.
- Reflective QoS Attribute.
- Maximum Packet Loss Rate for the uplink and downlink.

## 4.3.2 5G Media Streaming

### 4.3.2.1 Principles and Architectures

5G Media Streaming is built on the idea of enabling third-party media distribution beyond the MNO (Mobile Network Operator) and the 5G network acting not only as a bit pipe but to provide technical and commercial opportunities for collaboration. MNOs and content providers are generally highly interested in such collaboration models that permit monetizing video traffic on 5G and sharing revenue. MNOs are also interested in addressing the dilemma of ever-growing demand for media consumption on their networks - by 2026 according to [i.10], 50 % of mobile data will be on 5G and 77 % of this data will be video.

Challenges for pure over-the-top distribution include:

- 1) Quality of Experience issues (rebuffering and stall events) that are associated with the operator in the end user's mind.
- 2) Obscuring of traffic by end-to-end encryption using HTTPS.
- 3) Unidentified content eating into users' data caps.
- 4) The increasing demand for higher quality, new formats, new immersive and interactive experiences.

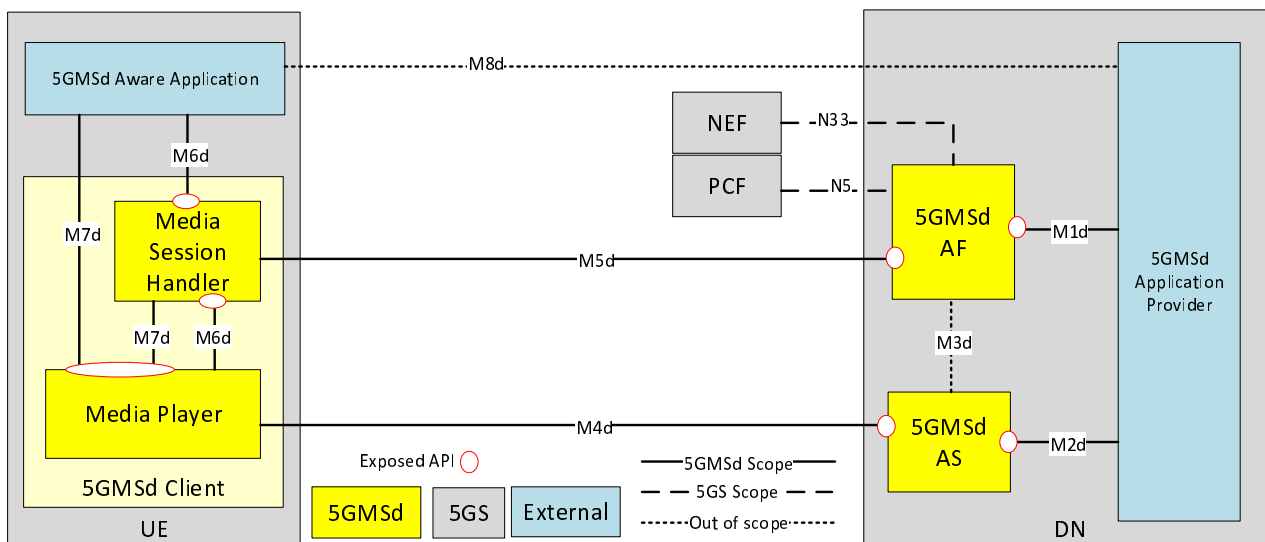
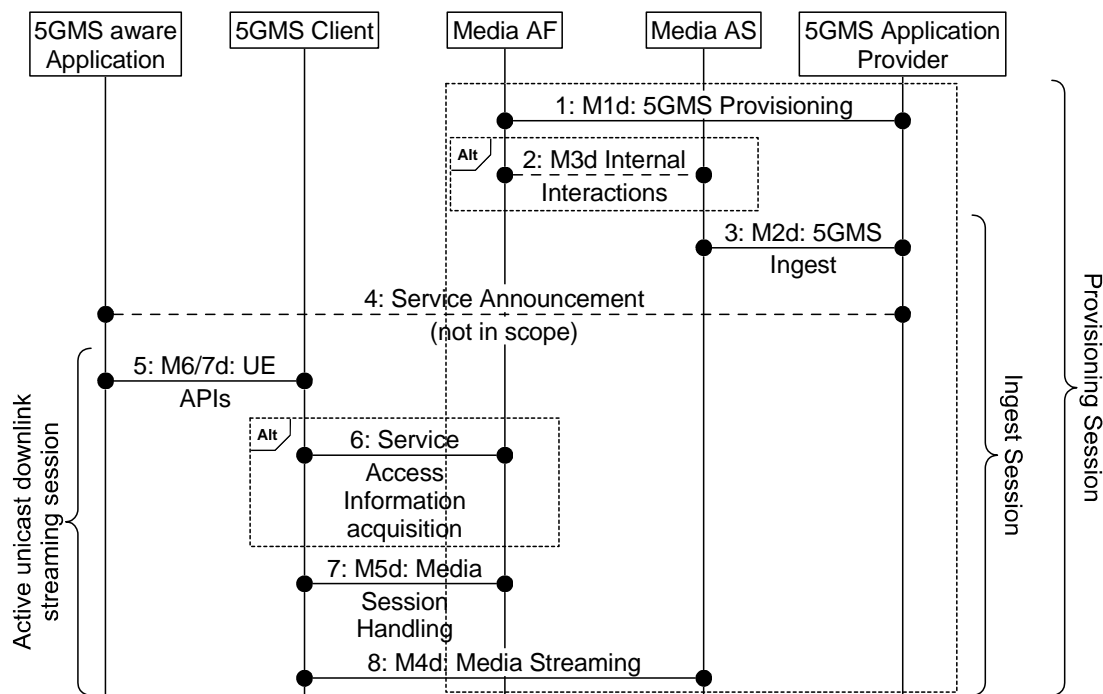

**Figure 4.3.2.1-1: 5G Media Streaming Downlink Architecture (see ETSI TS 126 501 [i.6])**

The approach taken for 5G Media Streaming is documented in ETSI TS 126 501 [i.6] and is shown in figure 4.3.2.1-1.

The framework is aligned with modern over-the-top media distribution practices. The specifications support MNOs and third-party media services to easily access 5G System and 5G Media Streaming features. 5G Media Streaming as defined in ETSI TS 126 501 [i.6] includes both, downlink and uplink streaming. In the context of the present document, only downlink streaming is considered.

The basic procedures are shown in figure 4.3.2.1-2, Provisioning, Ingest, Service Announcement, and media streaming session along with media session handling. It should be noted that while step 4 is considered out of scope for 5GMS, it is expected that DVB-I (in the role of 5GMS-Aware Application) defines service announcement.



<http://msc-generator.sourceforge.net> v6.3.13

**Figure 4.3.2.1-2: 5G Media Streaming Downlink: Basic call flows (see ETSI TS 126 501 [i.6])**

5G Media Streaming stage-3 specifications ETSI TS 126 512 [i.7] and ETSI TS 126 511 [i.11] provide an instantiation of 5G Media Streaming for one or a small subset of recommended technologies including codecs, formats, protocols and other functionalities. These specifications are introduced below in clauses 4.3.2.2 and 4.3.2.3, respectively.

### 4.3.2.2 5G Media Streaming - Protocols and APIs

The different interfaces and protocols that realize the 5G Media Streaming System are defined in ETSI TS 126 512 [i.7]. A *5GMS Application Function* (5GMS AF), deployed in the 5G Core Network of the MNO or in an external Data Network (DN), manages a *5GMS System*. This logical function embodies the control plane aspects of the system, such as provisioning, configuration and reporting:

- A *5GMS Application Provider* provisions 5GMS functions using a RESTful HTTP-based provisioning interface at reference point **M1**.
- Another RESTful HTTP-based configuration and reporting interface is exposed to UE-based 5GMS Clients at reference point **M5**.

A *5GMS Application Server* (5GMS AS), deployed in the 5G Core or in an External Data Network, provides 5G Media Streaming services to 5GMS Clients. This logical function embodies the data plane aspects of the 5GMS System that deals with media content:

- Content is ingested from 5GMS Application Providers at reference point **M2**. Both push- and pull-based ingest methods are supported, based on HTTP.
- Content is distributed to 5GMS Clients at reference point **M4** (after possible manipulation by the 5GMS AS). Standard pull-based content retrieval protocols (e.g. DASH) are supported at this reference point.

A *5GMS Client* deployed in the UE consumes 5G Media Streaming services. The 3GPP specifications are silent on whether this logical function is realized as shared UE middleware components or provided piecemeal by individual applications:

- A *Media Session Handler* subcomponent first retrieves its configuration (*Service Access Information*) from the 5GMS AF at reference point **M5** and then uses this configuration information to activate and exploit the currently provisioned 5GMS features. The 5GMS-Aware Application controls the Media Session Handler via a UE-internal API defined at reference point **M6**. This reference point could, for example, be realized as a Javascript API in a web browser.
- A *Media Player* subcomponent consumes media from the 5GMS AS at reference point **M4**. The *5GMS-Aware Application* controls the Media Player via a UE-internal API defined at reference point **M7**. This reference point could also be realized as a Javascript API in a web browser, for example.

### 4.3.2.3 5G Media Streaming - codecs and formats

5G Media Streaming also specifies the use of segment formats that are based on the Common Media Application Format (CMAF) in ISO/IEC 23000-19 [i.18]. By using this format, 5G Media Streaming is compatible with a broad set of segment-based streaming protocols including Dynamic Streaming over HTTP (DASH) and HTTP Live Streaming (HLS). For example, ISO/IEC 23009-1 [i.19] defines a detailed DASH profile for delivering CMAF content within a DASH Media Presentation using a converged format for segmented media content.



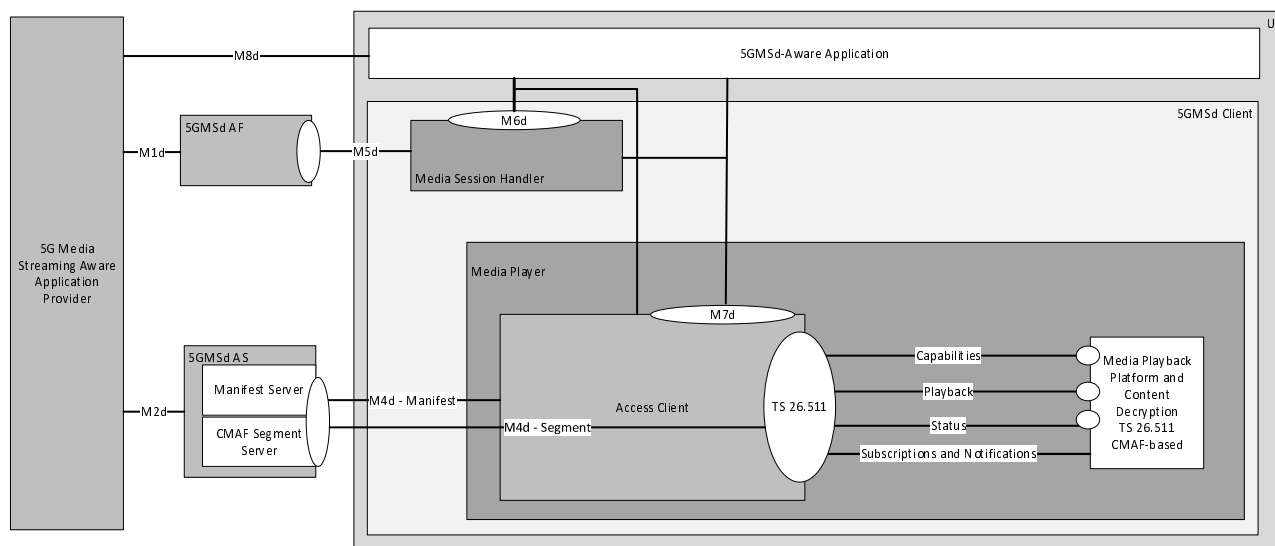

**Figure 4.3.2.3-1: Media Playback in downlink 5G Media Streaming Architecture  
(see ETSI TS 126 511 [i.11])**

5GMS media profiles for video, audio and subtitles based on the general constraints of ISO/IEC 23000-19 [i.18] are defined in ETSI TS 126 511 [i.11]. However, downlink 5G Media Streaming is not restricted to the media profiles defined in ETSI TS 126 511 [i.11]. Any CMAF media profile, for example for codecs defined in DVB specifications, may be distributed within downlink 5G Media Streaming.

#### 4.3.2.4 Deployment opportunities for 5G Media Streaming

5G Media Streaming permits value-added services. Examples are provided as follows:

- Telco operator CDN (Content Delivery Network) - the MNO acts as distributor/CDN.
- Content- and device-aware streaming.
- Premium QoS: Activating a QoS bearer or using a dedicated Network Slice with specific transport characteristics.
- Standardized and Extended (Conditional) Zero Rating provides following policies:
  - A: Notify the Player/Client that throttling is applied.
  - B: Instruct the Player to not exceed certain bitrate policies.
- Different charging policies.
- Dynamic Policies.

In the context of Dynamic Policies, figure 4.3.2.4-1 illustrates how Service Operation Points expressed in the content are mapped to network Policy Templates.

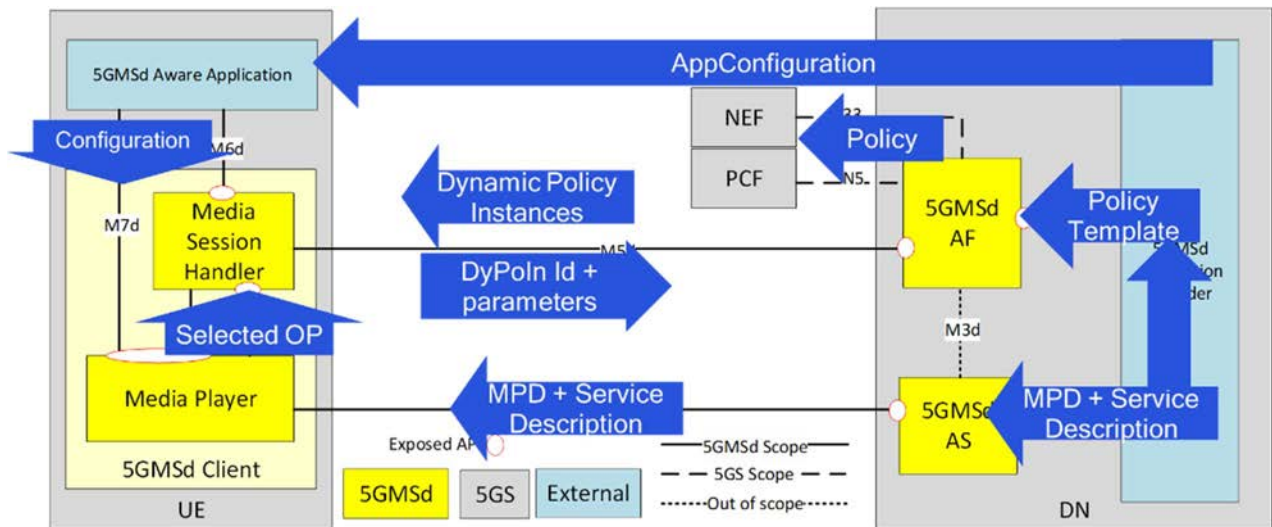

**Figure 4.3.2.4-1: Dynamic Policy Framework in 5G Media Streaming**

Service Operation Points identify long-lived profiles that will be used by streaming sessions. Policy Templates represent long-term agreements made between the Application Provider and the MNO. An Application Provider can limit what traffic and which users are allowed to use a specific Policy Template (e.g. based on an Internet domain name). A 5G Media Streaming session uses at most one of the allowed Policy Templates at any point in time. The Media Session Handler may pre-cache or retrieve periodically or on request the list of allowed Service Operation Points for a specific Application Provider. Two options may be used to realize different network policies:

- Option 1: Define each Service Operation Point as a Network Slice. The concept of Network Slice as a Service (NSaaS) is defined in ETSI TS 128 530 [i.29].
- Option 2: Define each Service Operation Point as a QoS Flow using flow description(s) of the transport session (see ETSI TS 123 502 [i.30]).

Service Operation Points can be mapped to manifest concepts, for example a specific Adaptation Set in DASH including the subset of Representations relevant to the Operation Point.

### 4.3.3 eMBMS and enhanced TV

While Multimedia Broadcast Multicast Services (MBMS) had been part of 3GPP specifications since Release 6 in 2005 based on UTRAN, and since Release 9 based on LTE (the evolution to LTE is also referred to as "eMBMS"), the dedicated requirements of broadcast service providers were only taken into account in 3GPP Release 14 some ten years later. Requirements for 3GPP enhancements for TV service support were developed in 3GPP Release 14 and are documented in ETSI TS 122 101 [i.26], clause 32.

Based on these requirements, 3GPP specifications have gradually evolved to meet the use cases and requirements in order to support broadcasting of linear television and radio services. In 3GPP TR 23.746 [i.27], a significant set of key issues relevant for the usage of MBMS for broadcast services is identified and these issues are subsequently addressed in 3GPP Release 14 specifications:

- Support of Free-To-Air (FTA) service over 3GPP.
- Broadcast-only service for UEs with no MNO broadcast subscription.
- Support of shared eMBMS functions.
- Decoupling of content, MBMS service and MBMS transport functions.
- Exposure of eMBMS service and transport capabilities to third parties.

Beyond the service layer enhancements, also in 3GPP Release 14 the use cases and scenarios for eMBMS services based on LTE were expanded to include terrestrial broadcasting (the feature also referred to as "EnTV"). This included new requirements:

- Network dedicated to TV broadcast via eMBMS.
- Single Frequency Network (SFN) deployments with Inter-Site Distance (ISD) significantly larger than a typical ISD associated with typical cellular deployments.
- Support for Receive-Only Mode (ROM) services and devices.

With the development of 5G from Release 15 onwards, 3GPP formulated requirements for the system and Radio Access Technology (RAT) in ETSI TS 122 261 [i.28] as part of the initial release for 5G, namely Release 15. In particular, broadcast is addressed in clause 6.13 of ETSI TS 122 261 [i.28]. Whereas the requirements are generic for a flexible broadcast/multicast system, only a subset of the requirements apply to broadcasting linear television and radio services, in particular those for 5G dedicated broadcast networks.

Several 3GPP specifications have been extended or newly developed over several releases to address the use cases and requirements for 5G dedicated broadcast networks. While it is expected that 3GPP will continue to address all the requirements for a flexible broadcast/multicast system in clause 6.13 of ETSI TS 122 261 [i.28] in future releases, with the completion of the Release 16, a comprehensive set of 3GPP specifications is available that fulfils the use cases and requirements for a 5G Broadcast System.

The work on enhanced TV in 3GPP is summarized in ETSI TR 136 976 [i.12].

## 4.4 ETSI JTC Broadcast Technology overview

### 4.4.1 LTE-based 5G Broadcast

The work on enhanced TV is summarized in ETSI TR 136 976 [i.12] provides the foundation for the specification work in ETSI JTC Broadcast published in December 2020 as ETSI TS 103 720 [i.8]. A more comprehensive overview of the changes introduced in Release 16 can be found in [i.20].

Several 3GPP specifications have been extended or newly developed over several releases to address the use cases and requirements for 5G dedicated broadcast networks. ETSI TS 103 720 [i.8] summarizes the basic features of a 5G Broadcast System for the carriage of linear television and radio services, and documents these as an implementation profile of a subset of 3GPP specifications. The LTE-based 5G Broadcast System is an instantiation of a 5G Broadcast System addressing the basic features that is based on a profile of 3GPP specifications available in Release 16.

Figure 4.4.1-1 depicts the reference architecture for the LTE-based 5G Broadcast System as defined in ETSI TS 103 720 [i.8].

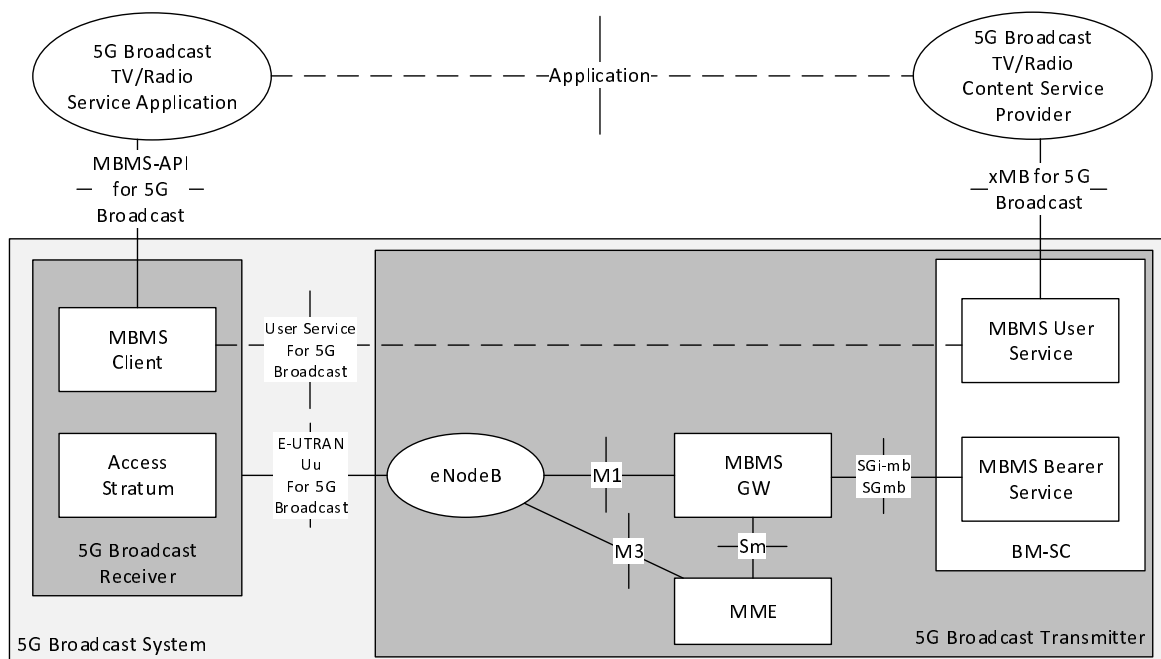

**Figure 4.4.1-1: Reference architecture for 5G Broadcast System for linear TV and radio services with LTE-based 5G Broadcast instantiation (see ETSI TS 103 720 [i.8])**

According to this figure, the reference points and protocols for the LTE-based 5G Broadcast System instantiation are:

- For the northbound Network API for 5G Broadcast, a profile of **xMB** as defined in ETSI TS 126 348 [i.13] and ETSI TS 129 116 [i.14] is defined in clause 5.5.2 of ETSI TS 103 720 [i.8].
- For the User Service for 5G Broadcast, a profile of the MBMS User Service as defined in ETSI TS 126 346 [i.5] is specified in clause 5.5.3 of ETSI TS 103 720 [i.8].
- For the RAN for 5G Broadcast, a profile of E-UTRAN **Uu** as defined in ETSI TS 136 300 [i.15], ETSI TS 136 211 [i.16] and ETSI TS 136 331 [i.17] is specified in clause 5.5.4 of ETSI TS 103 720 [i.8].
- For the Client API for 5G Broadcast, a profile of the **MBMS-API** as defined in ETSI TS 126 347 [i.4] is specified in clause 5.5.5 of ETSI TS 103 720 [i.8].

According to clause 5.3.2 of ETSI TS 103 720 [i.8], the following of types of 5G Broadcast Service are defined:

- 1) *5G Broadcast SA Service*: A 5G Broadcast Service that provides Service Announcement and originates in the BM-SC (or in the 5G Broadcast Transmitter) and terminates in the MBMS Client (or in the 5G Broadcast Receiver).
- 2) *5G Broadcast User Service*: A 5G Broadcast Service that provides user data, for example a linear television or radio service. The User Service originates in the Content Provider and terminates in the Application. Based on the delivery modes available for MBMS User Services, the following User Service types are defined in the present document:
  - a) *UDP Proxy*, supported by the Transport-only Proxy Delivery Mode.
  - b) *IP Packet Routing*, supported by the Transport-only Forward-only Delivery Mode.
  - c) *File Delivery*, supported by the download delivery mode and non-real-time file delivery in order to distribute files on a scheduled basis or in carousels.
  - d) *Segment Streaming*, supported by the download delivery mode and real-time segment delivery in order to distribute segment streaming services such as DASH, HLS and hybrid DASH/HLS.

For service discovery, details are provided in clause 5.12 of ETSI TS 103 720 [i.8]. For discovering all available 5G Broadcast Services, a 5G Broadcast Receiver identifies all PLMNs that carry 5G Broadcast Services. Then, for each identified PLMN carrying at least one 5G Broadcast Service, a 5G Broadcast Receiver finds the 5G Broadcast SA services in the range of associated TMGIs as defined in clause 5.11.2 of ETSI TS 103 720 [i.8]. Finally, for each service announced in the 5G Broadcast SA service a 5G Broadcast Receiver finds the 5G Broadcast User Services in the range of associated TMGIs as defined in clause 5.11.3 of ETSI TS 103 720 [i.8] based on the received service announcement.

5G Broadcast Services impose no requirements on the support of a unicast connection. However, a UE may choose to support unicast in addition to 5G Broadcast Services as introduced in clause 9 of ETSI TS 103 720 [i.8]. This permits hybrid broadcast service operation. According to ETSI TS 103 720 [i.8], the 5G Broadcast TV/Radio Application itself makes use of unicast to provide an improved service. Examples for this may be in the context of HbbTV® or DVB-I Service information. This may, for example, include an Electronic Program Guide (EPG) or an Electronic Service Guide (ESG).

## 4.5 5G-MAG Reference Tools overview

### 4.5.1 Background

5G-MAG has agreed to support the promotion and fostering of 5G media technologies by launching a development programme to implement a set of software-based Reference Tools. Sponsored by 5G-MAG, this activity aims at establishing a developer community, at creating common open source reference tools to support the implementation and interoperability of 5G Media technologies, and at collaborating with relevant SDOs on the validation and improvement of related specifications.

The initial steps of this activity have focused on the implementation of 3GPP Release 16 5G Broadcast and 5G Media Streaming. At the time of finalization of the present document, initial work on adding 3GPP Release 17 features is considered.

### 4.5.2 5G-MAG Reference Tools high-level architecture

Figure 4.5.2-1 depicts the reference architecture based on 3GPP Release 16 with independent chains including 5G Broadcast and 5G Media Streaming components. As the development of the reference tools is an ongoing activity, the latest status can be retrieved from [i.2].

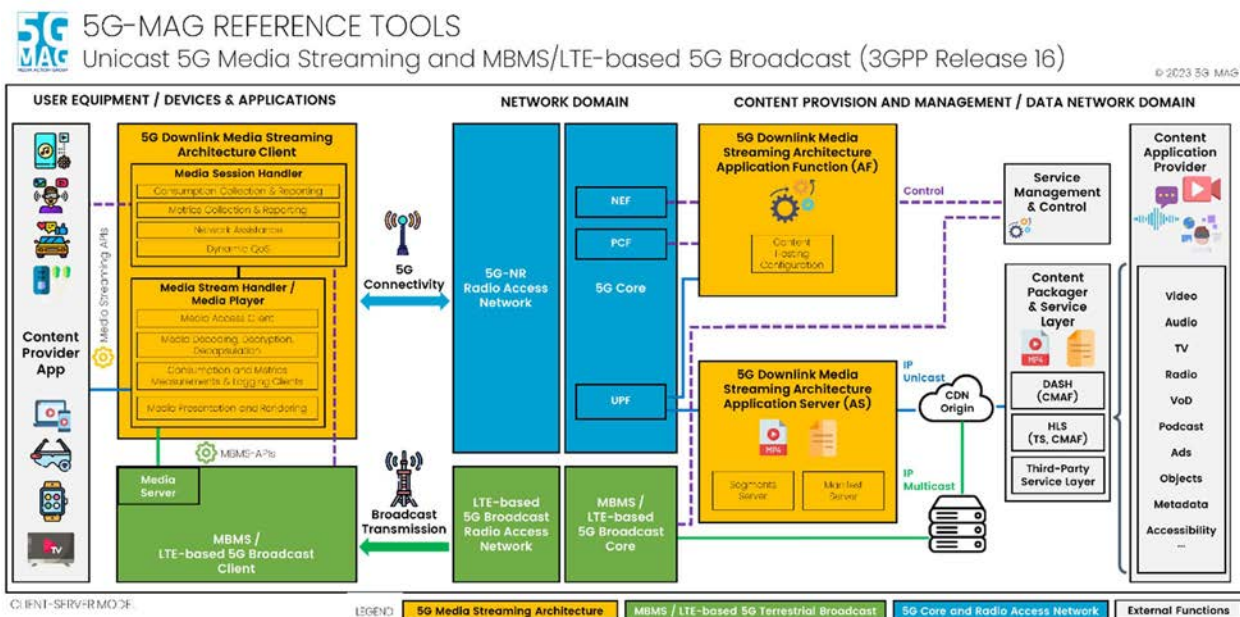

Figure 4.5.2-1: 5G-MAG Reference Tools architecture overview

Elements actively under development include the following:

- The **LTE-based 5G Broadcast RAN** provides an MBMS Transmitter (*rt-tx-poc*) that enables an over-the-air transmission of 5G Broadcast signals using a USRP SDR device ETSI TS 103 720 [i.8].
- The **LTE-based 5G Broadcast Client** consists of MBMS Modem, MBMS Client, and a Web-User-Interface (see clause 4.5.3).
- A **5GMS Application Function (5GMS AF)** that provides control functions to the Media Session Handler on the UE and/or to the 5G MS Application Provider, as defined in ETSI TS 126 501 [i.6].
- A **5GMS Application Server** which hosts 5G media functions, including Content Hosting as defined in ETSI TS 126 501 [i.6].
- The **5GMS Client** consists of a Media Stream Handler (Media Player) and Media Session Handler (see clause 4.5.4).

Other elements which are currently not considered for development, but which are part of the end-to-end chain include:

- Content Application Provider functions.
- Service Provider functions, including content packaging and publishing, as well as service management and control.
- LTE-based 5G Broadcast Core.
- 5GMSd-Aware Application, labelled in figure 4.5.2-1 as Content Provider App.

### 4.5.3 Reference client for LTE-based 5G Broadcast

Figure 4.5.3-1 shows the detailed architecture of 5G-MAG's reference 5G Media Client for LTE-based 5G Broadcast.

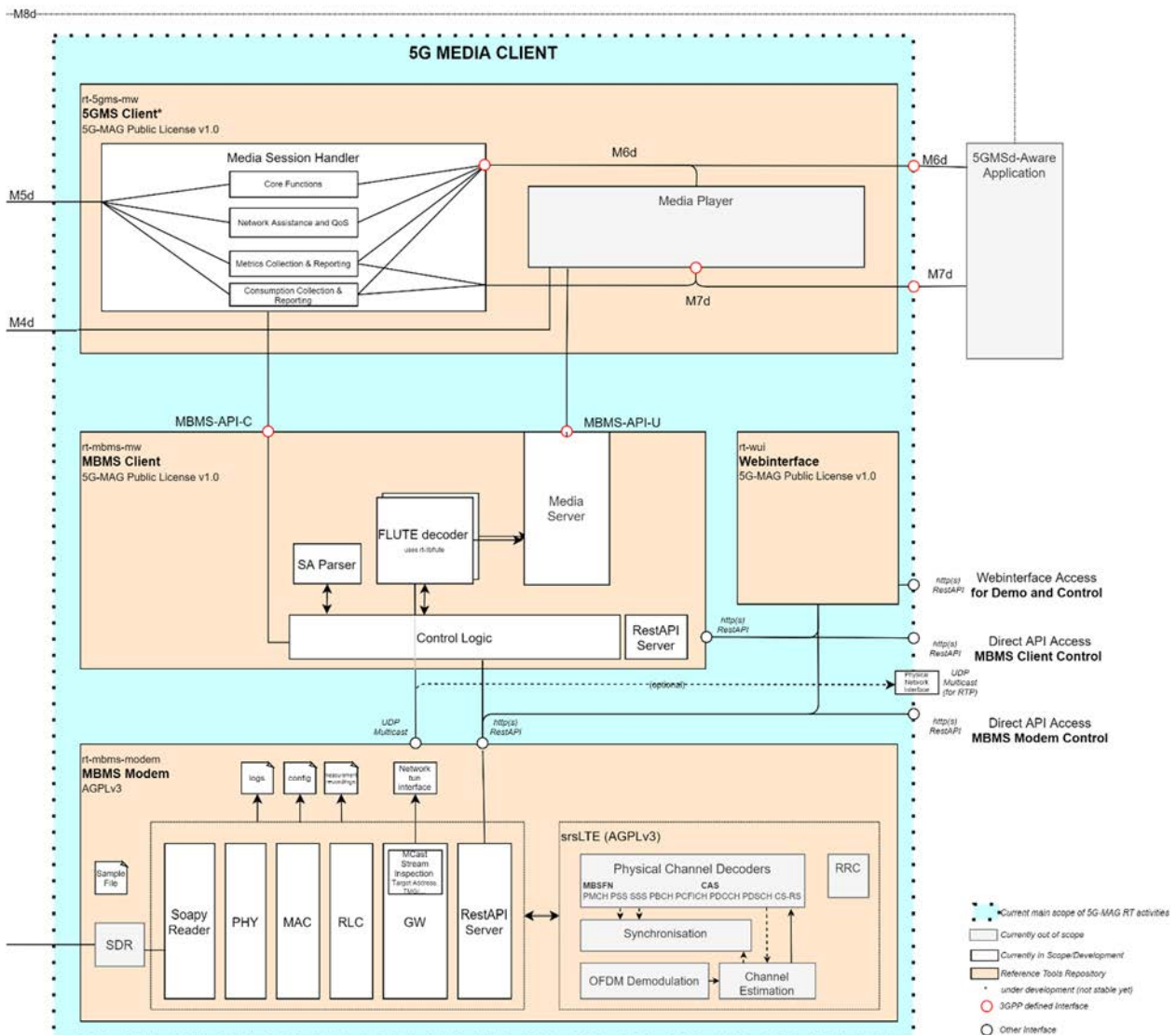

Figure 4.5.3-1: 5G-MAG Reference Tools client architecture

According to figure 4.5.3-1, the 5G-MAG reference 5G Media Client consists of four entities, instantiated as single repositories:

- The **MBMS Modem** (*rt-mbms-modem*) represents a receive-only modem for dedicated reception of LTE-based 5G terrestrial broadcast (with baseline capabilities of 3GPP Release 14 and some functionalities of 3GPP Release 16). It analyses the incoming digitized I/Q data streams from signals of the external SDR or a previously recorded sample file and outputs the received signal as UDP multicast packets (either on the physical network interface card or for the MBMS Client (*rt-mbms-client*)). The output multicast addresses can contain for example RTP payload or with FLUTE encapsulated Service Announcements (SA) or payload (e.g. DASH, HLS). The RestAPI Server provides a RESTful HTTP interface for configuration and information exchange with the Web-based User Interface and for direct API access. This repository is built on libraries from the srsRAN project.
- The **MBMS Client** (*rt-mbms-mw*) analyses the multicast packets from the MBMS Modem and decrypts FLUTE encrypted packets. The Service Announcement parser analyses the transmitted services (e.g. DASH, HLS) and makes them available on a Media Service (a cache), according to ETSI TS 123 246 [i.3], ETSI TS 126 347 [i.4] and ETSI TS 126 346 [i.5]. The RestAPI Server provides a RESTful HTTP interface for configuration and information exchange with the Web-based User Interface and for direct API access. The MBMS Client can be accessed from MBMS-Aware Applications via the interfaces **MBMS-API-U** and **MBMS-API-C**.

- The **Web-User-Interface** (*rt-wui*) gathers data from MBMS Modem, MBMS Client and MBMS using a RestAPI and can be accessed by a web browser on the local or network host. Views include data from the modem (e.g. center frequency, bandwidth, SCS, constellation diagrams, BER and BLER of different logical channels, UDP multicast addresses of services), MBMS Client (content of the service announcement and content of the cache) and DASH.js and HLS.js player for testing purposes.
- The **5GMS Client** (see clause 4.5.4) plays the role of an MBMS-Aware Application from the perspective of the MBMS Client.

#### 4.5.4 Reference client for 5G Media Streaming

According to figure 4.5.2-1, the 5G-MAG reference implementation of the 5GMS Client consists of:

- The **Media Stream Handler** (*rt-5gms-media-stream-handler*) according to ETSI TS 126 501 [i.6] and ETSI TS 126 512 [i.7] which, in the case of downlink media streaming is a **Media Player**.
- The **Media Session Handler** (*rt-5gms-media-session-handler*) is used for consumption collection and reporting as well as metrics collection and reporting from the Media Player.

An 5GMS-Aware Application can access the 5GMS Client using the client APIs at reference points **M6d** and **M7d**.

---

## 5 DVB-I over 5G Reference architecture

### 5.1 High-level architecture

Figure 5.1-1 illustrates the principal system approach for running DVB-I services over 5G systems. The principal approach is to leverage existing and well-defined interfaces, reference points and APIs defined in DVB and 5G in order to connect and establish services. Ideally, implementations of these devices would enable these services without requiring any changes to existing standards.



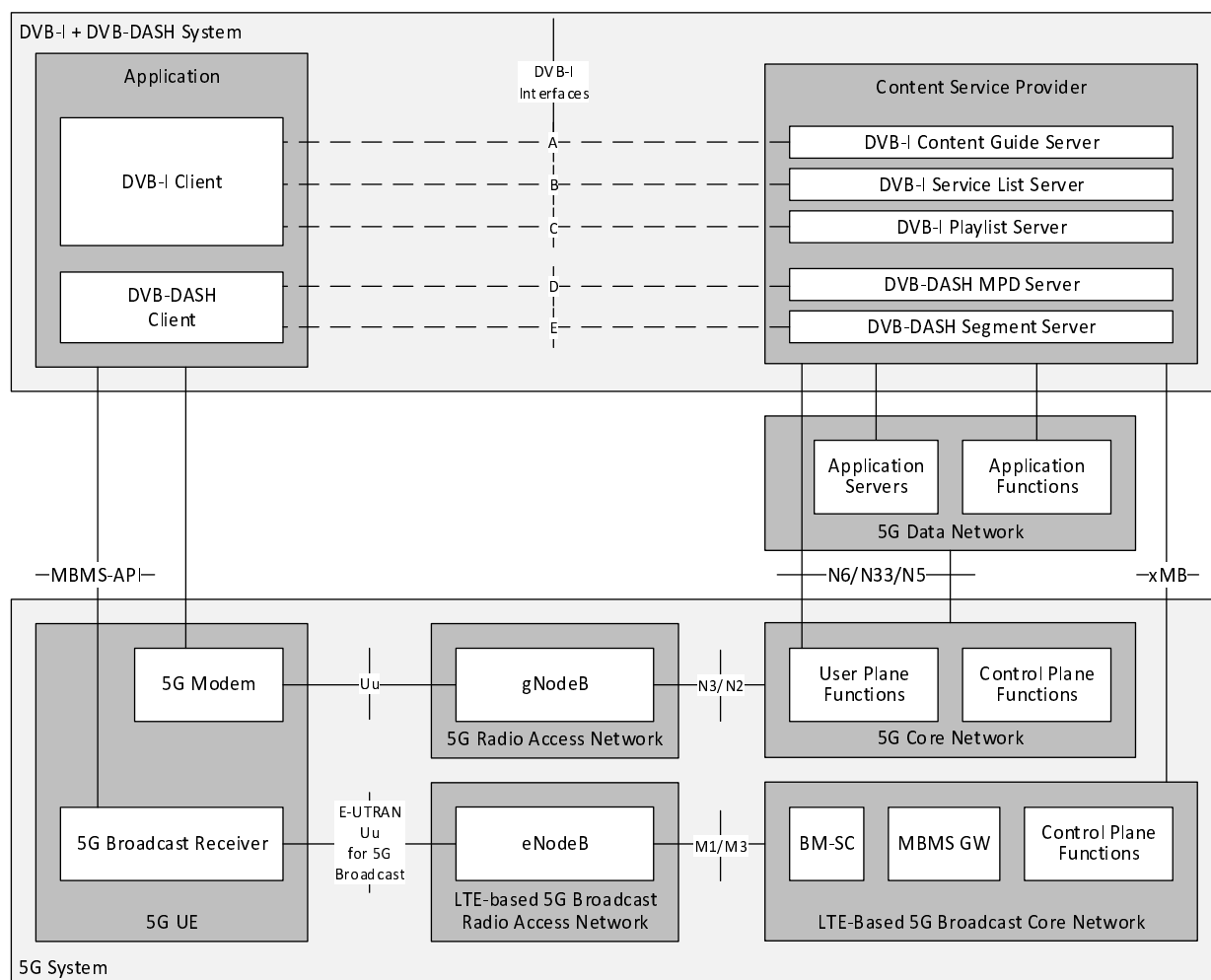

**Figure 5.1-1: High level architecture for DVB-I Services over 5G Systems**

The top part describes the DVB-I system and a DVB-DASH system. It includes a client which consists of a DVB-I Client, a DVB-DASH Client and a Broadcast TV/Radio Service application. The client is connected via DVB-I logical interfaces to the Content Service Provider's DVB-I and DVB-DASH servers. The logical interfaces are carried over the 5G System which is depicted in the bottom part. The DVB-I Client and DVB-DASH Client are connected via client APIs to the broadcast-capable 5G UE. The UE interfaces to the 5G Core network via the 5G and LTE-Based 5G Broadcast Radio Access Network.

The Core Network functions interfaces towards the Content Service Provider's DVB-I and DVB-DASH servers via:

- **xMB** API for LTE-Based 5G Broadcast.
- **N6** and IP Connectivity for User plane directly or via 5G Media Streaming Application Functions and Servers.

5G Media Streaming Application Functions interface towards the 5G Core Network Control Plan Functions (PCF and NEF) via reference points **N33** and **N5**.

## 6 Service scenarios

### 6.1 Introduction

The present clause details a set of service scenarios based on the corresponding commercial requirements and the DVB-I over 5G Reference architecture:

- Standalone DVB-I Service using 5G Broadcast.

- DVB-I Service using 5G Media Streaming.
- DVB-I service offerings simultaneously over broadcast and unicast, also referred to as hybrid service offerings.

Each scenario includes workflows with guidance in reference to relevant standards specifications. Gaps identified in existing specifications are documented as recommended changes to the relevant specifications under the control of the respective organization:

- DVB;
- 3GPP; or
- ETSI.

## 6.2 Standalone DVB-I Service using 5G Broadcast

### 6.2.1 Description

In DVB BlueBook C100 [i.1], three use cases motivate specifications for the delivery of a standalone DVB-I service using 5G Broadcast, namely:

- Use Case 2 (5G Broadcast/Unicast hybrid delivery to handheld devices) in clause 5.3 of [i.1];
- Use Case 3 (5G Broadcast standalone with Unicast for EPG) in clause 5.4 of [i.1]; and
- Use Case 6 (DVB-I Hybrid Service over 5G) in clause 5.7 of [i.1].

Relevant Commercial Requirements indicated in *italics* are copied from [i.1] below as follows:

**Table 6.2.1-1: Relevant Commercial Requirements reproduced from DVB BlueBook C100 [i.1]**

- |  |
|--|
| <ul style="list-style-type: none"> <li>• <i>"Req 2.2.1: DVB shall provide specifications to enable self-contained DVB-I Services to be delivered over a 5G Broadcast System as defined in ETSI TS 103 720.</i></li> <li>• <i>Req 2.3.1 DVB shall provide specifications to enable provisioning of Self-contained DVB-I Services delivered over 5G Broadcast as defined in ETSI TS 103 720.</i></li> <li>• <i>Req 2.4.2 The DVB-I over 5G System shall be able to provide an entry point (in the form of a reference to a DVB I service list registry) to announce DVB-I services over a 5G Broadcast System.</i></li> <li>• <i>Req 2.4.3 The DVB-I over 5G System shall be able to announce in a 5G Broadcast signal the location of one or more DVB-I service lists.</i></li> <li>• <i>Req 2.4.4 The DVB-I over 5G System shall be able to embed the DVB-I service list in a 5G Broadcast signal.</i></li> <li>• <i>Req 2.4.5 The DVB-I over 5G System shall be able to provide an updated DVB-I service list in a 5G Broadcast signal.</i></li> <li>• <i>Req 2.4.7 The DVB-I Service List shall define a service instance type for services delivered using a 5G Broadcast System.</i></li> <li>• <i>Req 2.4.10 DVB specifications shall allow a DVB-I client to unambiguously identify a specific DVB I editorial service (i.e. a service which carries specific editorial content) received over 5G Broadcast or 5G Media Streaming based on radio layer access parameters (e.g. frequency + TMGI/service identifier for 5G Broadcast), in a similar way as can be done on DVB broadcast networks (i.e. DVB triplet, orbital position/frequency, etc.).</i></li> <li>• <i>Req 2.4.15 DVB specifications shall support signalling of Free-To-Air (FTA) DVB-I service instances delivered over a 5G Broadcast System.</i></li> <li>• <i>Req 2.4.16 DVB specifications shall enable signalling of Receive Only Mode (ROM) for DVB-I service instances delivered over a 5G Broadcast System.</i></li> <li>• <i>Req 2.4.17 The DVB-I over 5G System shall be able to announce in the 5G Broadcast signal the location of Content Guide endpoints.</i></li> <li>• <i>Req 2.6.2 DVB specifications shall support the distribution of DVB-I services via a 5G Broadcast System.</i></li> <li>• <i>Req 2.6.6 DVB specifications shall support Free-To-Air (FTA) delivery of services over a 5G Broadcast System.</i></li> <li>• <i>Req 2.6.7 DVB specifications shall support Receive Only Mode (ROM) for the reception of services from a 5G Broadcast System."</i></li> </ul> |
|--|

NOTE: Modal verbs appearing in this table are non-normative in the context of the present document.

While a pure 5G Broadcast service may not be the primary deployment choice (because it is expected that 5G Broadcast receivers will typically be capable of connecting through unicast), it is beneficial to provide at least a basic self-contained DVB-I service via 5G broadcast, for example for receivers that are not connected through a unicast network, for example due to temporary out-of-coverage, or because of unavailability of a subscription, or due to overload of the unicast system.

## 6.2.2 Architecture

Based on the above description and requirements as well as the technology introduction in clause 4, this clause provides a possible deployment architecture for "Standalone DVB-I Service using 5G Broadcast" shown in figure 6.2.2-1. The DVB-I + DVB-DASH System operates as a 5G Broadcast aware application. Specifically in this architecture, the following assumptions are made:

- The 5G Broadcast TV/Radio Content Service Provider runs DVB-I Service List Server, DVB-I Playlist Server, DVB-DASH MPD Server as well as DVB-DASH Segment Server.
- The 5G Broadcast TV/Radio Content Service application includes a DVB-DASH client as well as a DVB-I Client which deals with Playlist and Service List handling.

Alternative architectures, for which the DVB-I system includes possibly additional functions (e.g. an DVB-MABR head-end and client) or alternative ones (e.g. a DVB-IPTV server and client instead of DVB-DASH) are provided in clause 6.2.5.

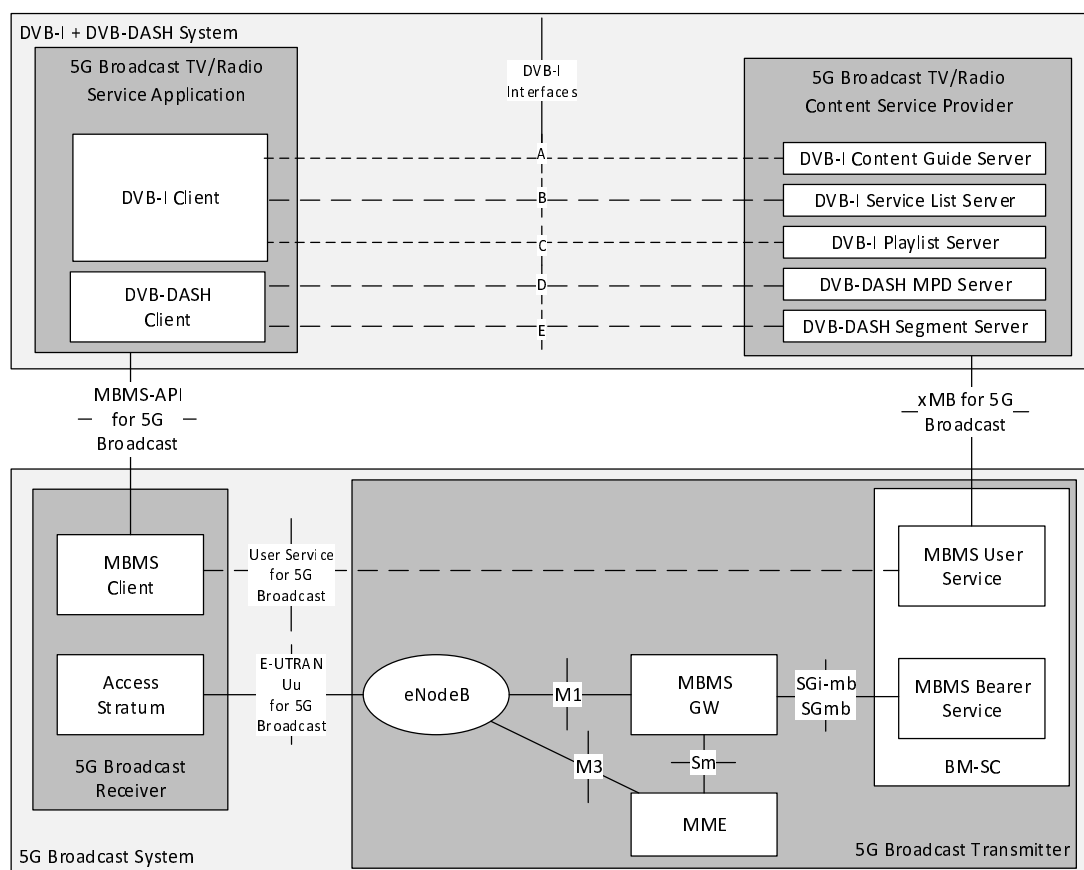

**Figure 6.2.2-1: Architecture for DVB-I Standalone via 5G Broadcast**

In figure 6.2.2-1, several logical interfaces (dashed lines) are documented, namely, DVB-I interfaces **A**, **B**, **C**, **D**, and **E**, as well as the User Service Announcement for 5G Broadcast. In the specific scenario documented in this clause, only a single physical interface exists, namely the E-UTRAN **Uu** for 5G Broadcast. This interface is expected to carry all information exchanged via the logical DVB-I and MBMS User Service architecture. For an application, the reference points on network side, **xMB**, as well as the **MBMS-API** are used in order to communicate the information.

In the scenario considered in the following, only a basic service offering is considered. Content Guides and Playlists are not included, and hence only information shared over DVB-I interfaces **B**, **D**, and **E** are considered.

## 6.2.3 Procedures and call flows

### 6.2.3.1 Service provisioning procedure

The procedures that a 5G Broadcast TV/Radio Service Content Provider uses to provision DVB-I services in a 5G Broadcast Transmitter are depicted in figure 6.2.3.1-1.

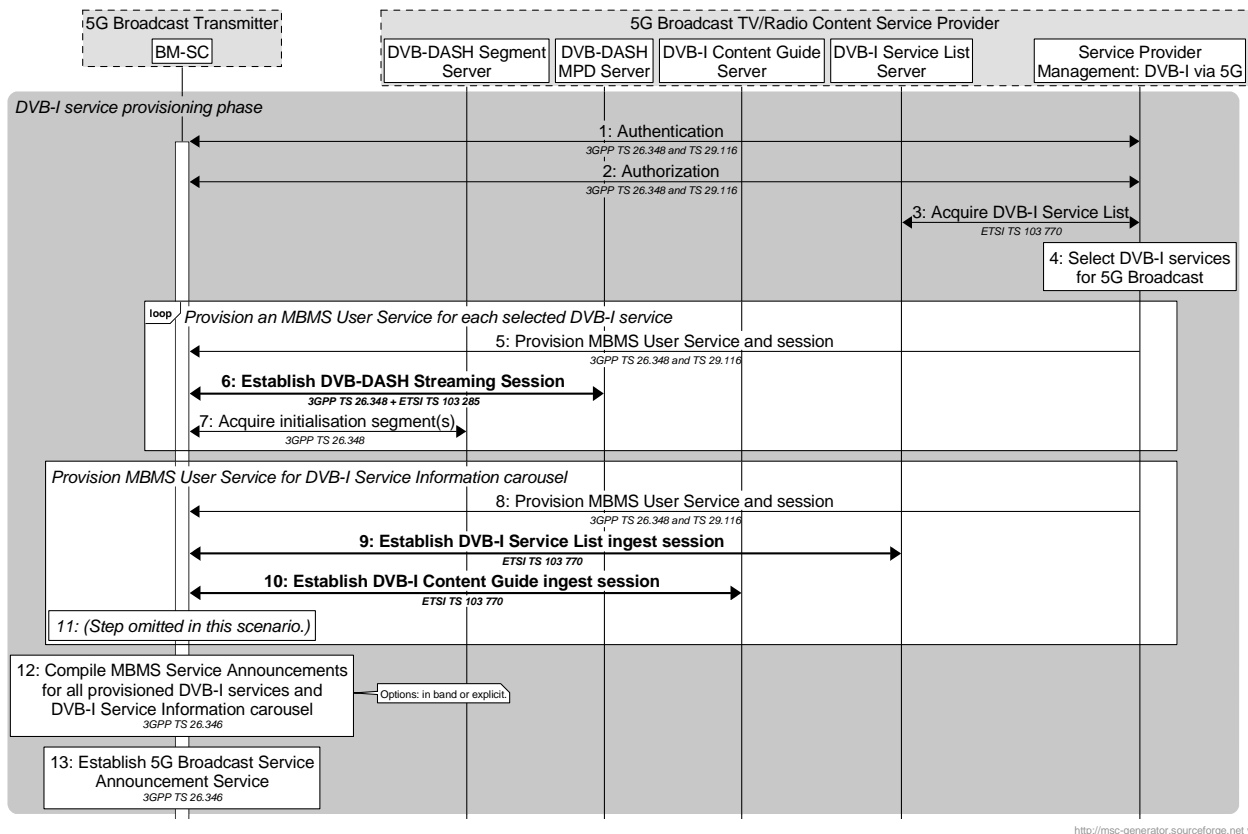

Figure 6.2.3.1-1: Call flow sequence for DVB-I service provisioning

Pre-requisites:

- It is assumed that the Service Provider Management function is aware of which DVB-I services are intended to be made available via 5G Broadcast.

The steps for provisioning DVB-I services over 5G Broadcast are as follows:

- Step 1: The Service Provider Management function authenticates itself with the BM-SC (see clause 5.2.2 of ETSI TS 126 348 [i.13] and clause 4.4 of ETSI TS 129 116 [i.14]).
- Step 2: The Service Provider Management function authorizes its access to the BM-SC (see clause 5.2.3 of ETSI TS 126 348 [i.13] and clause 4.4 of ETSI TS 129 116 [i.14]).
- Step 3: The Service Provider Management function acquires the DVB-I Service List from the DVB-I Service List Server using the procedure specified in clause 5.1.2 of ETSI TS 103 720 [i.8].
- Step 4: The Service Provider Management function selects which DVB-I services are to be made available via 5G Broadcast.

The following three steps are repeated for each DVB-I service selected in the previous step:

Step 5: An MBMS User Service and session of type *Application* are provisioned for each DVB-I service selected in the previous step (see clause 5.3.2 of ETSI TS 126 348 [i.13] and clauses 4.4.4 and 4.4.5 of ETSI TS 129 116 [i.14]). The location of the presentation manifest for the DVB-I service on the DVB-DASH MPD Server is configured in the Application Entry Point URL property of the session. The session ingest mode is configured as *Pull*.

NOTE 1: ETSI TS 103 770 [i.21] does not require the DVB-DASH MPD Server to support push mode, so it is assumed here that the session needs to be provisioned in pull mode.

In addition, a session of type *Files* may be provisioned under the same MBMS User Service to convey DVB-I documents (such as the DVB-I Service List and the DVB-I Content Guide) as an in-band *DVB-I Service Information carousel* (see clause 4.4.5 of ETSI TS 129 116 [i.14]). The session ingest mode is configured as *Pull*. The set of DVB-I documents to be carouselled is specified either in a file list at the time of provisioning or else the URL of a file delivery manifest listing the DVB-I documents to be carouselled is provisioned (see table 5.2.2.1-1 of ETSI TS 129 116 [i.14]). In either case, the *Keep updated interval* and *Periodic update interval* properties are configured so that the BM-SC automatically checks periodically for updates to the referenced DVB-I documents.

NOTE 2: ETSI TS 103 720 [i.8] does not require a 5G Broadcast Receiver to support simultaneous reception of more than one 5G Broadcast User Service (i.e. reception of more than one MBMS User Service, each with a unique TMGI).

NOTE 3: It is the responsibility of the Service Provider Management function to reprovision the set of DVB-I services in the BM-SC if the service line-up changes.

Step 6: A DVB-DASH Streaming Session is established at reference point xMB-U between the BM-SC and the DVB-DASH MPD Server for the DVB-I service provisioned in the previous step (see clause 5.4.6 of ETSI TS 126 348 [i.13], clause 4.4.5 of ETSI TS 129 116 [i.14] and ETSI TS 103 285 [i.22]) and a DVB-DASH MPD is acquired from the DVB-DASH MPD Server using pull-based content ingest according to interactions D1 and D2 as specified in clause 4.1 of ETSI TS 103 770 [i.21].

Step 7: Initialization Segments referenced by the DVB-DASH MPD acquired in the previous step are acquired by the BM-SC from the DVB-DASH Segment Server at reference point xMB-U using pull-based content ingest for the MPD acquired in the previous step (see clause A.2 of ETSI TS 126 348 [i.13]).

NOTE 4: The choice of content ingest mode is part of the xMB session properties provisioned in step 5.

NOTE 5: ETSI TS 103 770 [i.21] does not require the DVB-DASH Segment Server to support push mode, so it is assumed here that the session needs to be provisioned in pull mode.

Then:

Step 8: A separate MBMS User Service and session of type *Files* is typically provisioned to convey DVBI documents (such as the DVB-I Service List and the DVB-I Content Guide) as a *DVB-I Service Information carousel* (see clause 5.3.2 of ETSI TS 126 348 [i.13] and clauses 4.4.4 and 4.4.5 of ETSI TS 129 116 [i.14]). The session ingest mode is configured as *Pull*. The set of DVB-I documents to be carouselled is specified either in a file list at the time of provisioning or else the URL of a file delivery manifest listing the DVB-I documents to be carouselled is provisioned (see table 5.2.2.1-1 of ETSI TS 129 116 [i.14]). In both cases, the *Keep updated interval* and *Periodic update interval* properties are provisioned appropriately in the session to ensure that the BM-SC automatically checks periodically for updates to the referenced DVB-I documents.

Alternatively, the DVB-I documents may be replicated in each MBMS User Service corresponding to a DVB-I service, as described in step 5 above.

Step 9: The DVB-I Service List ingest session is established at reference point xMB-U between the BM-SC and the DVB-I Service List Server (see clause 5.5.2 of ETSI TS 126 348 [i.13] and clause 6.2.3 of ETSI TS 129 116 [i.14]) and the DVB-I Service List document is acquired from the DVB-I Service List Server using pull-based content ingest according to interactions B1 and B2 as specified in clause 5.1.2 of ETSI TS 103 770 [i.21].

NOTE 6: The BM-SC is provisioned in step 8 to monitor for updates to this quasi-static document on the DVB-I Service List Server and to download them automatically when it changes (see clause 5.3.4 of ETSI TS 126 348 [i.13] and clause 4.4.4.3 of ETSI TS 129 116 [i.14]). The root element of the DVB-I Service List document includes a version number attribute to explicitly signal that its content has changed.

Step 10: A DVB-I Content Guide ingest session is established at reference point xMB-U between the BM-SC and the DVB-I Content Guide Server (see clause 5.5.2 of ETSI TS 126 348 [i.13] and clause 6.2.3 of ETSI TS 129 116 [i.14]) and the DVB-I Content Guide documents are acquired from the DVB-I Content Guide Server using pull-based content ingest according to interactions A1 and A2 as specified in clause 4.1 of ETSI TS 103 770 [i.21].

NOTE 7: The BM-SC is provisioned in step 8 to monitor for updates to these documents on the DVB-I Content Guide Server and to download them automatically when they change (see clause 5.3.4 of ETSI TS 126 348 [i.13] and clause 4.4.4.3 of ETSI TS 129 116 [i.14]).

Step 11: This step is not applicable in this scenario.

Finally:

Step 12: An MBMS Service Announcement is compiled by the BM-SC for all DVB-I services provisioned in step 5 above and for the DVB-I Service Information carousel provisioned in step 8 (see ETSI TS 126 346 [i.5]). MBMS User Service announcement allows to defined service classes using the attribute @serviceClass in the user service description. **The service class identifier is similar to MIME types and provides a unique identity to services. An appropriate DVB-I naming scheme is preferred.**

Step 13: The 5G Broadcast Service Announcement Service (see clause 5.4.2 of ETSI TS 103 720 [i.8]) is established ready for the transmission of MBMS Service Announcements.

DVB-I services over 5G Broadcast are now provisioned.

### 6.2.3.2 Service transmission procedure

The procedures that a BM-SC uses to transmit DVB-I services over 5G Broadcast are depicted in figure 6.2.3.2-1.

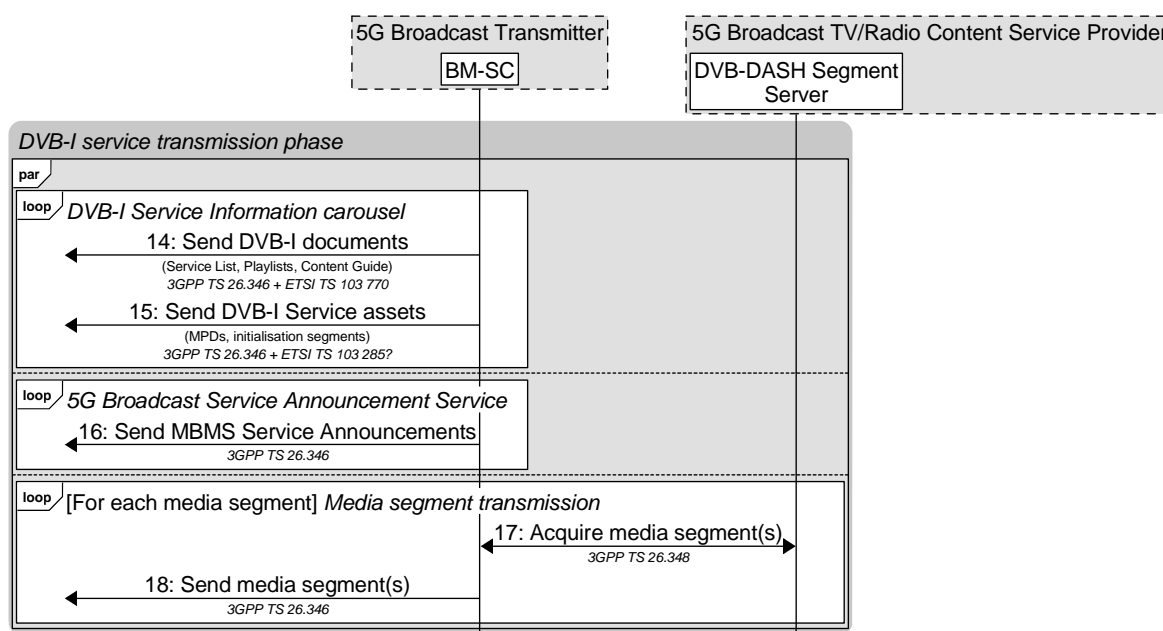

<https://gitlab.com/msc-generator/v8.0>

**Figure 6.2.3.2-1: Call flow sequence for DVB-I service transmission**

Service information about the DVB-I services is carouselled repeatedly by the BM-SC according to the following steps:

- Step 14: DVB-I documents (Service List and Content Guide) are carouselled in the MBMS User Service provisioned for this purpose (the DVB-I Service Information carousel).
- Step 15: The quasi-static assets of each DVB-I service (MPD and initialization segments) are also transmitted in the MBMS User Service provisioned for the DVB-I Service Information carousel.

In parallel:

- Step 16: The MBMS Service Announcement for each provisioned DVB-I service is carouselled on the 5G Broadcast Service Announcement Service.

In parallel, media segments for the DVB-I services provisioned in step 5 are ingested, serialized and transmitted by the BM-SC according to the following steps:

- Step 17: Each media segment is acquired at reference point xMB-U by the BM-SC from the DVB-DASH Segment Server (see clause 5.5.2 of ETSI TS 126 348 [i.13] and clause 6.3.3 of ETSI TS 129 116 [i.14]) according to interactions E1 and E2 in ETSI TS 103 770 [i.21].
- Step 18: The media segment is transmitted by the BM-SC (see clauses 5.4.1, 5.6 and 5.7 of ETSI TS 126 346 [i.5]) in the MBMS service provisioned for the appropriate DVB-I service alongside the assets in step 15.

### 6.2.3.3 Service discovery procedure

The procedures that a 5G Broadcast TV/Radio Service Application uses to discover a DVB-I service that has been made available via 5G Broadcast are depicted in figure 6.2.3.3-1.

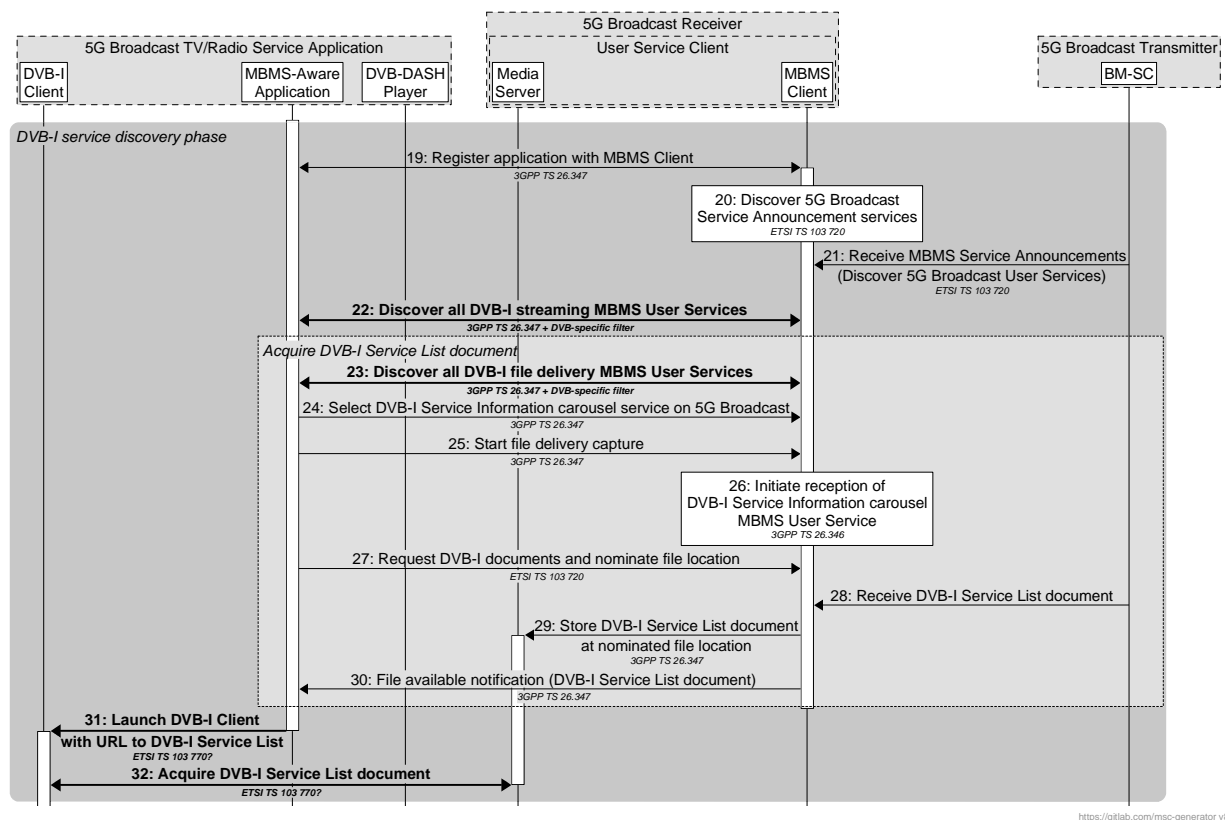

Figure 6.2.3.3-1: Call flow sequence for DVB-I service discovery

The steps are as follows:

- Step 19: As part of its initialization, the MBMS-Aware Application uses the MBMS Client API to register itself with the MBMS Client (see clause 6.2.3.2 of ETSI TS 126 347 [i.4]).
- Step 20: As a consequence, the MBMS Client initiates its procedure to discover the 5G Broadcast Service Announcement Service (see clause 5.12 of ETSI TS 103 720 [i.8]).
- Step 21: MBMS Service Announcements for all currently active 5G Broadcast User Services are received by the MBMS Client from the 5G Broadcast Service Announcement Service generated by the BM-SC.

NOTE 1: These correspond to the MBMS Service Announcements sent in step 16.

Subsequently:

- Step 22: As part of its initialization, the MBMS-Aware Application uses the MBMS Client API to discover all MBMS User Services that are DVB-I services (see clause 6.3.3.4 of ETSI TS 126 347 [i.4]). **It uses a specific filter as a parameter to the request that limits the set of responses to DVB-I services.**

NOTE 2: The way the filter is passed between the MBMS-Aware application and the DVB-I client is not standardized.

- Step 23: As part of its initialization, the MBMS-Aware Application uses the MBMS Client API to discover the file delivery MBMS User Service carrying DVB-I Service Information (see clause 6.2.3.4 of ETSI TS 126 347 [i.4]). **It uses a specific filter as a parameter to each of these two requests that limits the set of responses to the type of service of interest.**
- Step 24: Using the MBMS Client API, the MBMS-Aware Application selects the file delivery MBMS User Service corresponding to the DVB-I Service Information carousel (see clause 6.2.3.6 of ETSI TS 126 347 [i.4]) by setting the service class filter.



- Step 25: Using the MBMS Client API, the MBMS-Aware Application instructs the MBMS Client to start reception of the file delivery MBMS User Service corresponding to the MBMS service identifier obtained in the previous step (see clause 6.2.3.7 of ETSI TS 126 347 [i.4]).
- Step 26: As a consequence, the MBMS Client initiates reception of the file delivery MBMS User Service carrying the DVB-I documents (see clause 6.2.2 of ETSI TS 126 347 [i.4]).
- Step 27: The MBMS-Aware Application uses the MBMS Client API to request reception of the DVB-I documents. It nominates a file location for each of them (see clause 6.2.3.5 of ETSI TS 126 347 [i.4]).
- Step 28: The DVB-I Service List document is received by the MBMS Client from the BM-SC on the next rotation of the MBMS User Service carrying the DVB-I Service Information carousel.

NOTE 3: This is one of the DVB-I documents sent in step 14.

- Step 29: The DVB-I Service List document is stored by the MBMS Client in the local Media Server at the location nominated in step 27 (see clause 6.2.3.8 of ETSI TS 126 347 [i.4]).
- Step 30: By means of a callback registered in step 26, the MBMS Client notifies the MBMS-Aware Application that the DVB-I Service List document is available at the location it nominated.
- Step 31: The MBMS-Aware Application launches the DVB-I Client and passes it the location of the DVB-I Service List document.
- Step 32: The DVB-I Client retrieves the DVB-I Service List document from the local Media Server using the location passed in the previous step.

#### 6.2.3.4 Service selection procedure

The procedures that a 5G Broadcast TV/Radio Service Application uses to select a DVB-I service that has been made available via 5G Broadcast for presentation are depicted in figure 6.2.3.4-1.

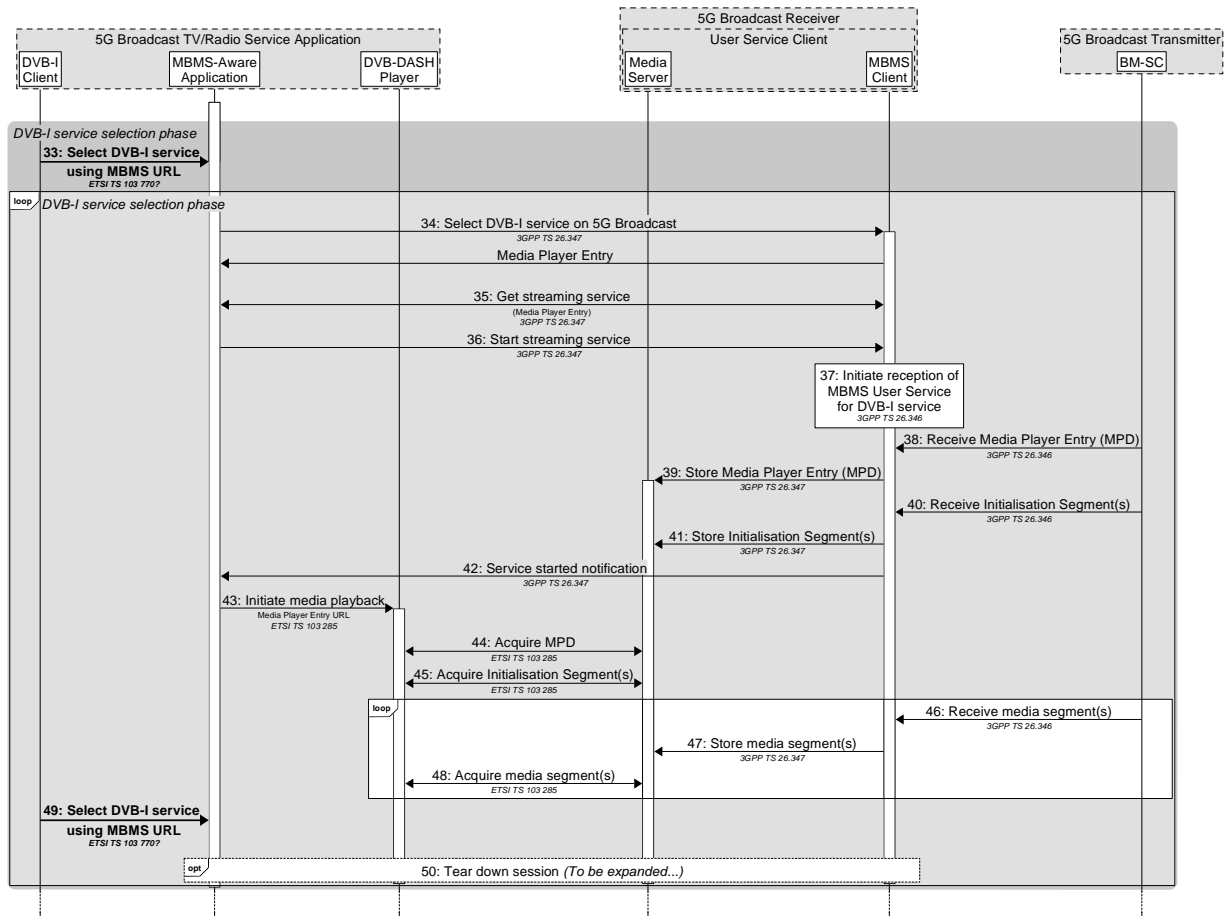

**Figure 6.2.3.4-1: Call flow sequence for DVB-I service selection**

When a DVB-I service available via 5G Broadcast is selected for presentation (e.g. as a result of a user interaction with the DVB-I Client), the steps are as follows:

- Step 33: The DVB-I Client invokes the MBMS-Aware Application, passing the MBMS-URL of the selected MBMS User Service as a parameter.
- Step 34: Using the MBMS Client API, the MBMS-Aware Application selects the streaming MBMS User Service corresponding to the nominated DVB-I service (see clause 6.3.3.13 of ETSI TS 126 347 [i.4]). A reference to the Media Player Entry is returned in response.
- Step 35: Using the MBMS Client API, the MBMS-Aware Application resolves the Media Player Entry reference into the corresponding MBMS service identifier (see clause 6.3.2 of ETSI TS 126 347 [i.4]).
- Step 36: Using the MBMS Client API, the MBMS-Aware Application instructs the MBMS Client to start reception of the MBMS User Service corresponding to the MBMS service identifier obtained in the previous step (see clause 6.3.3.7 of ETSI TS 126 347 [i.4]).
- Step 37: As a consequence, the MBMS Client initiates reception of the MBMS User Service corresponding to the selected DVB-I service.

Subsequently:

- Step 38: The Media Player Entry document (i.e. MPEG-DASH MPD) for the DVB-I service is received by the MBMS Client from the MBMS User Service being transmitted by the BM-SC.

NOTE 1: This is one of the DVB-I service assets sent in step 15.

- Step 39: The Media Player Entry document (i.e. MPEG-DASH MPD) is stored by the MBMS Client in its Media Server.

Step 40: DVB-DASH initialization segments for the DVB-I service are received by the MBMS Client from the MBMS User Service being transmitted by the BM-SC.

NOTE 2: This is one of the DVB-I service assets sent in step 15.

Step 41: The DVB-DASH initialization segments are stored by the MBMS Client in its Media Server.

Step 42: As a result of receiving the Media Player Entry document (i.e. MPEG-DASH MPD), all initialization segments required by the presentation described in the MPD, and at least one media segment (see clause 6.3.3.8 of ETSI TS 126 347 [i.4]) the MBMS Client sends a notification to the MBMS-Aware Application that the streaming service requested in step 36 has started successfully.

Step 43: The MBMS-Aware Application initiates media playback by passing the MPD URL to the Media Player. This URL points to the local Media Server.

Step 44: The Media Player retrieves the MPD acquired in step 34 from the local Media Server.

Step 45: The Media Player acquires the initialization segments referenced by the MPD retrieved in the previous step from the Media Server.

The following steps are then repeated for each media segment in the presentation:

Step 46: A media segment is received from the BM-SC by the MBMS Client.

NOTE 3: This corresponds to a media segment sent in step 18.

Step 47: The received media segment is stored in the local Media Server by the MBMS Client.

Step 48: The Media Player acquires the media segment from the Media Server according to the presentation timeline indicated in the MPD retrieved in step 44.

### 6.2.3.5 Service reselection procedure

When a different DVB-I service available via 5G Broadcast is selected for presentation at some later point in time (e.g. as a result of a user interaction with the DVB-I Client to change the channel), the steps are as follows:

Step 49: The DVB-I Client invokes the MBMS-Aware Application, passing the MBMS-URL of the newly selected service as a parameter.

The streaming session of the currently presented DVB-I service is first torn down in step 49.

NOTE: Session teardown procedure is for further study.

Finally, a streaming session for the newly selected service is initiated from step 33 onwards.

## 6.2.4 Identified gaps in existing DVB/3GPP/ETSI specifications

The following gaps are identified in existing specifications in relation to this scenario:

- In reference to steps 5 and 8 of clause 6.2.3.1, it is unclear from table 5.2.2-1 in ETSI TS 129 116 [i.14] how *Keep updated interval* and *Periodic update interval* properties should be configured.
- In reference to step 5 of clause 6.2.3.1, ETSI TS 103 720 [i.8] does not require a 5G Broadcast Receiver to support simultaneous reception of more than one 5G Broadcast User Service (i.e. reception of more than one MBMS User Service, each with a unique TMGI). Consider updating ETSI TS 103 720 [i.8] to recommend support simultaneous reception of more than one 5G Broadcast User Service.
- In reference to steps 9 and 10 of clause 6.2.3.1: Is it possible that the BM-SC is provisioned in step 8 to monitor for updates? Stage 2 has a mechanism for notifying the BM-SC. Possible gap in the stage 3 xMB-C API.
- In reference to step 12, a service class filter for DVB-I services is needed to be defined by DVB in order to select DVB-I services.

- In reference to step 33, an extension is needed such that a service instance can refer to a 5G Broadcast/MBMS URL and include a new set of service delivery parameters specifically for 5G Broadcast. The extension may either be defined in ETSI TS 103 770 [i.21] or in an MBMS (e.g. ETSI TS 126 347 [i.4]) or 5G Broadcast (ETSI TS 103 720 [i.8]) specification.

## 6.2.5 Alternative scenarios

### 6.2.5.1 Introduction

Building on the architecture and call flows provided in previous subclauses of clause 6.2, this clause extends the architecture to address variations in the DVB and DVB-I system including possibly additional functions (e.g. a DVB-MABR *Multicast server* and *Multicast gateway*) or alternative ones (e.g. a DVB-IPTV head-end and HNED instead of DVB-DASH).

The focus in this clause is on architectures and basic reference points and interfaces. The detailed extensions and modifications to call flows in clause 6.2.3 is left for further study, but preliminary considerations are provided.

### 6.2.5.2 DVB-MABR over 5G Broadcast

According to clause 4.2.3, DVB-MABR as defined in ETSI TS 103 769 [i.23] defines a reference architecture (also shown in figure 4.2.3-1) for ingesting media objects, using either a pull- or push-based HTTP mechanism via **P<sub>in</sub>**, into a *Multicast server* deployed at a head-end site and transmitting them as a sequence of multicast group-addressed packets over a suitably provisioned IP access network to a population of *Multicast gateway* devices deployed near the end user. This referenced point is referred to as **M**.

In the following considered scenario, the suitably provisioned IP access network is a 5G Broadcast network provisioned at reference point **xMB-C**. A system that combines DVB-I, DVB-DASH, DVB MABR and 5G Broadcast is shown in figure 6.2.5.2-1. The logical DVB-I interfaces **A**, **B**, **C**, **D** and **E**, as well as the User Service Announcement for 5G Broadcast are retained; DVB-MABR reference point **M** is added.

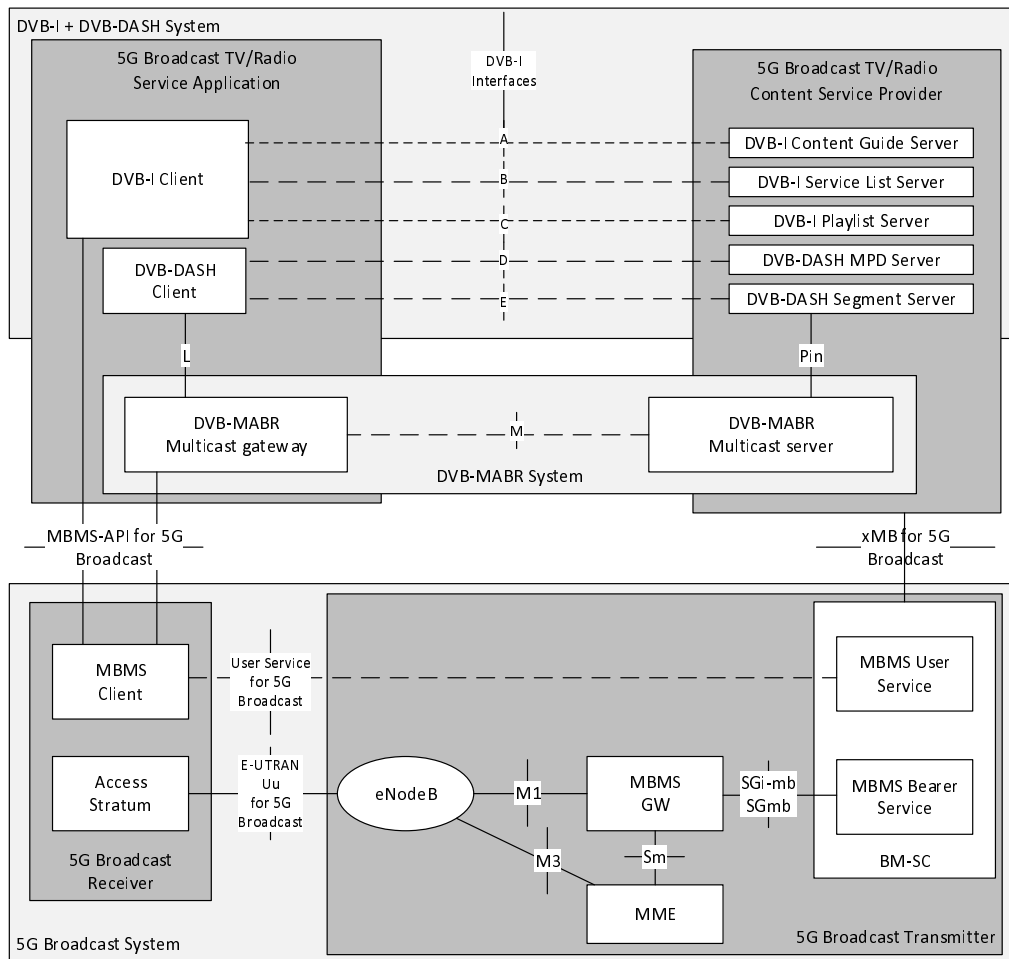

**Figure 6.2.5.2-1: DVB-MABR over 5G Broadcast transport-only mode**

In the scenario documented in this clause, again only a single physical interface exists between the 5G Broadcast Transmitter and the 5G Broadcast Receiver, namely the E-UTRAN **Uu** for 5G Broadcast. This interface is expected to carry all information exchanged via the combined logical DVB-I, DVB-MABR and MBMS User Service architectures:

- The DVB-DASH content is processed in the DVB-ABR *Multicast server* which establishes a *transport-only* MBMS User Services ingest session at reference point **xMB-U** in order to push multicast IP packets of the configured DVB-MABR multicast transport session(s) into the BM-SC.
- At the receiver, the 5G Broadcast TV/Radio Service Application invokes the **MBMS-API** to establish a packet interface that allows the DVB-MABR *Multicast gateway* to receive the multicast IP packet stream distributed via 5G Broadcast. The regenerated DVB-DASH content is then provided to the DVB-DASH Client via logical reference point **L**.

In this scenario, DVB-I service information metadata documents may be distributed in parallel using MBMS File Delivery modes.

The procedures and call flows described in clause 6.2.3 are extended or modified as follows to support the above scenario:

- In figure 6.2.3.2-1, DVB-I service transmission, the following is changed:
  - A non-flow-controlled push-based packet ingest session is established at reference point **xMB-U** with the DVB-MABR *Multicast server* instead of a pull-based content ingest session with the DVB-DASH Segment Server.
  - In step 17, the multicast transport session packets generated by the DVB-MABR *Multicast server* are pushed into the BM-SC at reference point **xMB-U** using transport-only mode as defined in ETSI TS 126 348 [i.13].

- In step 18, the multicast IP packets are sent using the transparent delivery mode as defined in ETSI TS 126 346 [i.5].
- In figure 6.2.3.4-1, DVB-I service selection:
  - The 5G Broadcast TV/Radio Service Application instantiates the DVB-MABR *Multicast gateway* function.
  - The MBMS Client in the 5G Broadcast Receiver presents a packet interface at reference point **MBMS-API** instead of a Media Server for use by the DVB-MABR *Multicast gateway* function.
  - In step 46, the packet stream of the DVB-MABR multicast transport session is received and pushed to the *Multicast gateway* which makes the reassembled media objects available to the DVB-DASH Player at reference point **L** as playback delivery objects.

The detailed handling of the presentation manifest (DVB-DASH MPD) and Initialization Segments in this scenario are for further study.

### 6.2.5.3 DVB-NIP over 5G Broadcast

According to clause 4.2.4, the DVB-NIP specification describes several receiver architectures based around two logical functions:

- a DVB-NIP Gateway; and
- a DVB-NIP Client function, as shown in figure 4.2.4.3-1.

While in the DVB-NIP reference architecture a DVB-specified IP broadcast delivery mechanism is considered for the signalling and DVB-MABR multicast transport sessions for media transmission at reference point **M**, the delivery may alternatively be carried out through 5G Broadcast. A system that combines DVB-I, DVB-DASH, DVB-MABR, DVB-NIP and 5G Broadcast is shown in figure 6.2.5.3-1. The logical DVB-I interfaces **A**, **B**, **C**, **D** and **E**, the DVB-MABR reference point **M**, as well as the User Service Announcement for 5G Broadcast are retained. The DVB-I service information metadata documents are additionally carried at reference point **M**.

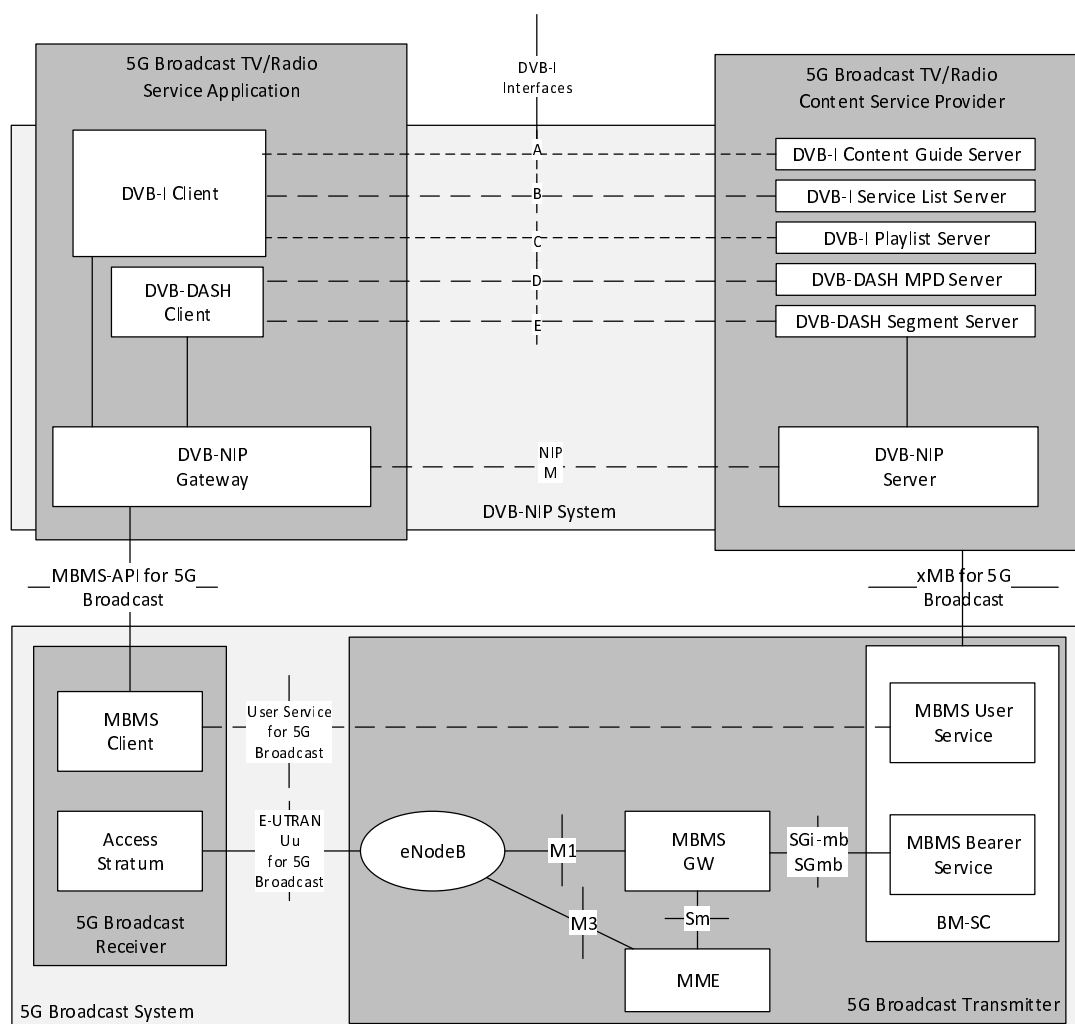

**Figure 6.2.5.3-1: DVB-NIP over 5G Broadcast Transport-only mode**

In the scenario documented in this clause, again only a single physical interface exists between the 5G Broadcast Transmitter and the 5G Broadcast Receiver, namely the E-UTRAN **Uu** for 5G Broadcast. This interface is expected to carry all information exchanged via the combined logical DVB-I, DVB-MABR, DVB-NIP and MBMS User Service architectures:

- The DVB-DASH content is processed in the DVB-ABR *Multicast server*, and the DVB-I service information metadata documents are carried in the DVB-MABR multicast gateway configuration transport session or else in object carousels in-band with individual multicast transport sessions. The NIP Multicast Server establishes a *transport-only* MBMS User Services ingest session at reference point **xMB-U** in order to push multicast IP packets of the configured multicast transport session(s) into the BM-SC.
- At the receiver, the 5G Broadcast TV/Radio Service Application invokes the **MBMS-API** to establish a packet interface that allows the DVB-NIP Gateway to receive the multicast IP packet stream distributed via 5G Broadcast. The regenerated DVB-I signalling is thus provided to the DVB-I Client and the DVB-DASH content is provided to the DVB-DASH Client.

The call flows to support this scenario are simpler than those documented in clause 6.2.3: DVB-I service information metadata is not delivered separately via 5G Broadcast, but is rather conveyed via DVB-MABR multicast transport sessions in transport-only MBMS User Services.

The exact mapping of DVB-NIP services to one or multiple MBMS User Services is for further study.

### 6.2.5.4 DVB-IPTV over 5G Broadcast

According to clause 4.2.5, DVB-IPTV as defined in ETSI TS 102 034 [i.33] provides architectures and protocols for transport of MPEG-2 TS-based DVB Services over multicast-capable IP networks and is known as DVB-IPTV. The interface to the Home Network End Device (HNED) defined as reference point **IPI-1** represents the end-terminal interface for a DVB-IPTV service. DVB-IPTV can be used to encapsulate any MPEG-2 Transport Stream compliant with ETSI TS 101 154 [i.25], whether containing single or possibly multiple programs.

In this scenario, the interface to the HNED is instantiated by a 5G Broadcast network. Secondly, each DVB-IPTV single program service is described using a separate service in the DVB-I Service List.

A system that combines DVB-I, DVB-IPTV and 5G Broadcast is shown in figure 6.2.5.4-1. The logical DVB-I interfaces **A**, **B**, and **C**, as well as the User Service Announcement for 5G Broadcast are retained; the logical interface **IPI-1** as defined in ETSI TS 102 034 [i.33] is added.

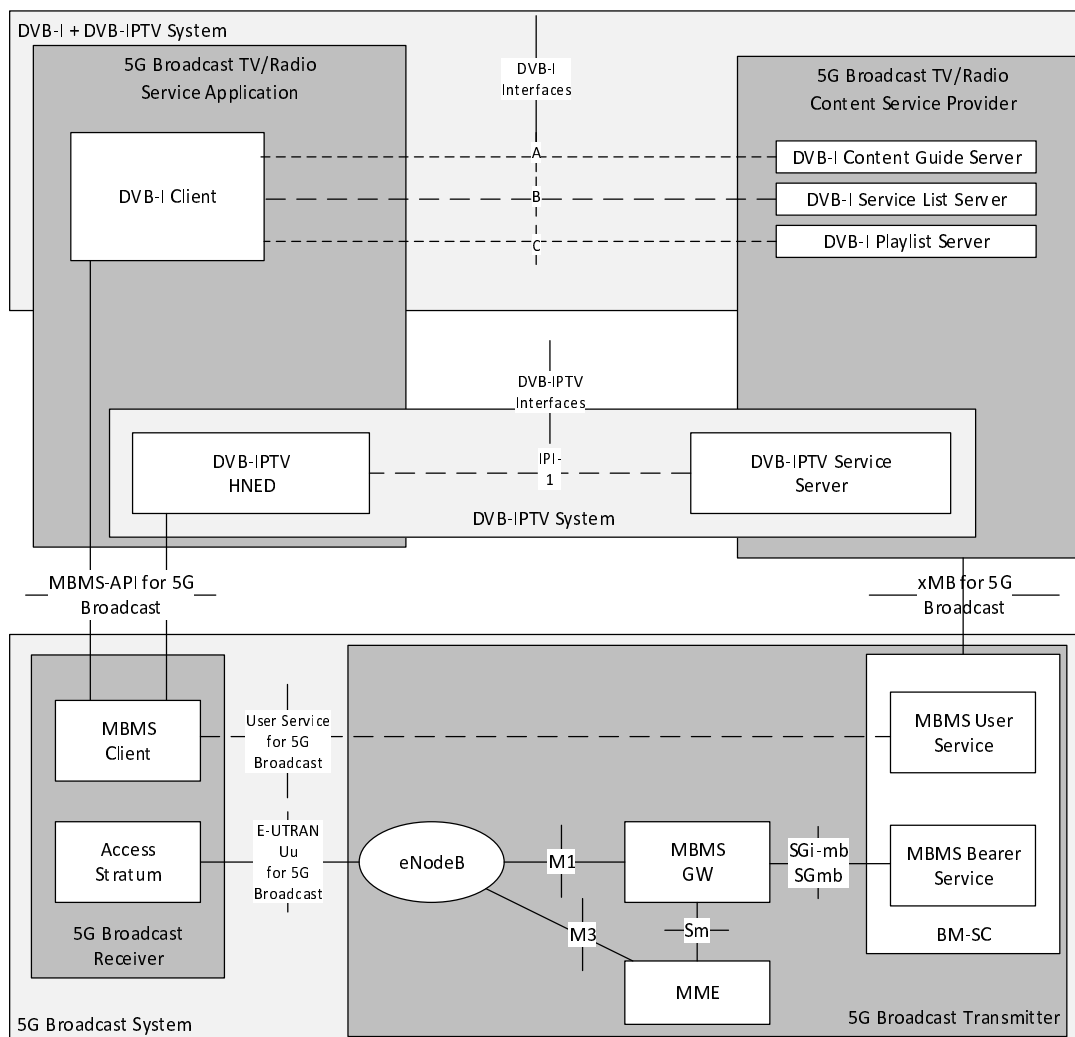

**Figure 6.2.5.4-1: DVB-IPTV for 5G Broadcast**

In the scenario documented in this clause, again only a single physical interface exists between the 5G Broadcast Transmitter and the 5G Broadcast Receiver, namely the E UTRAN **Uu** for 5G Broadcast. This interface is expected to carry all information exchanged via the logical DVB-I, DVB-IPTV and MBMS User Service architectures:

- The DVB MPEG-2 TS content is processed in the DVB-IPTV head-end which establishes a *transport-only* MBMS User Services ingest session at reference point **xMB-U** in order to push multicast IP packets of the configured DVB-IPTV service(s) into the BM-SC.
- At the receiver, the 5G Broadcast TV/Radio Service Application invokes the **MBMS-API** to establish a packet interface that allows the DVB-HNED to receive the multicast IP packet stream distributed via 5G Broadcast.



In this scenario, DVB-I service information metadata may be distributed in parallel using MBMS File Delivery modes. The call flow modifications are similar to those documented in clause 6.2.5.2. More details are for further study.

## 6.3 DVB-I Service using 5G Media Streaming

### 6.3.1 Description

In DVB BlueBook C100 [i.1], one use case motivates specifications for the delivery of a DVB-I service using 5G Media Streaming, namely:

- Use Case 1: DVB-I over 5G Media Streaming in clause 5.2 of [i.1].

Relevant commercial requirements indicated in *italics* are copied from [i.1] below as follows:

**Table 6.3.1-1: Relevant Commercial Requirements reproduced from DVB BlueBook C100 [i.1]**

<ul style="list-style-type: none"> <li>• <i>"Req 2.2.2: DVB shall provide specifications to enable self-contained DVB-I Services over a 5G Media Streaming System as defined in ETSI TS 126 501.</i></li> <li>• <i>Req 2.3.1: DVB shall provide specifications to enable provisioning of Self-contained DVB-I Services delivered over 5G Media Streaming as defined in ETSI TS 126 501.</i></li> <li>• <i>Req 2.4.1: DVB specifications shall support the announcement of DVB-I services via 5G Media Streaming.</i></li> <li>• <i>Req 2.4.8: The DVB-I Service List shall define a service instance type for services delivered using a 5G Media Streaming System.</i></li> <li>• <i>Req 2.6.1: DVB specifications shall support the distribution of DVB-I services via a 5G Media Streaming System.</i></li> <li>• <i>Req 2.6.3: DVB specifications shall specify how to make use of 5G Media Streaming functionalities for DVB-I Services, in particular Content Hosting (geofencing included), Dynamic QoS Policies and Network Assistance."</i></li> </ul>
NOTE: Modal verbs appearing in this table are non-normative in the context of the present document.

### 6.3.2 Architecture

See clause 4.3.2.1.

### 6.3.3 Procedures and call flows

#### 6.3.3.1 Service provisioning procedure

The procedures that a 5GMSd Application Provider uses to provision DVB-I services in a 5GMS System are depicted in figure 6.3.3.1-1.

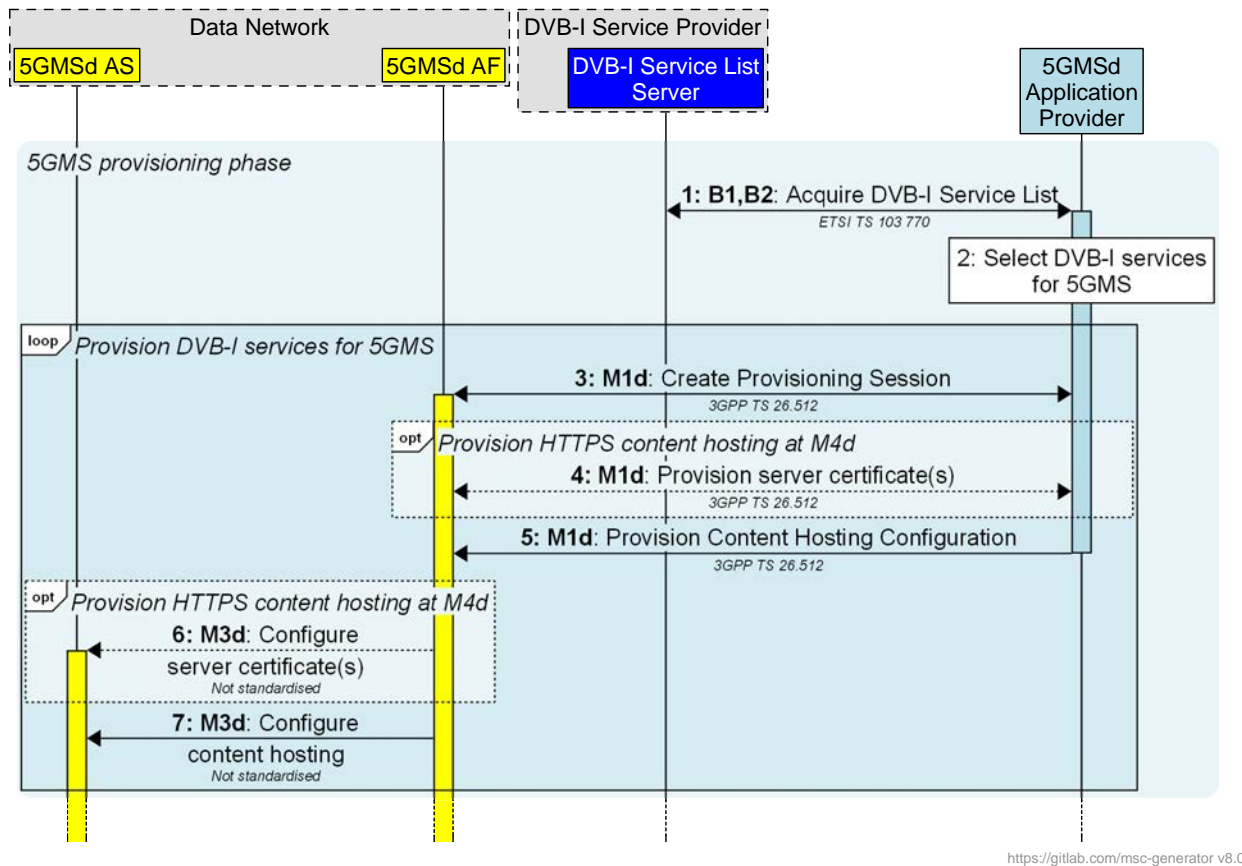

**Figure 6.3.3.1-1: Call flow sequence for provisioning DVB-I services via 5G Media Streaming**

The steps for provisioning DVB-I services over 5GMS are as follows:

- Step 1: The 5GMSd Application Provider acquires the DVB-I Service List from the DVB-I Service List Server using the procedure specified in clause 5.1.2 of ETSI TS 103 720 [i.8].
- Step 2: The Service Provider Management function selects which DVB-I services are to be made available via 5G Broadcast.

Depending on the structure of the content URLs, the following steps may be followed once for all in-scope DVB-I services or once per DVB-I service:

- Step 3: The 5GMSd Application Provider creates a Provisioning Session at the 5GMSd AF using the M1d Provisioning Sessions API specified in clauses 4.3.2 and 7.2 of ETSI TS 126 512 [i.7].
- Step 4: If it requires HTTPS content hosting at reference point M4d, the 5GMSd Application Provider provisions one or more server certificate subresources of the Provisioning Session at the 5GMSd AF for use with the Content Hosting Configuration in the following step using the M1d Server Certificates API specified in clauses 4.3.6 and 7.3 of ETSI TS 126 512 [i.7].
- Step 5: The 5GMSd Application Provider provisions a Content Hosting Configuration subresource of the Provisioning Session at the 5GMSd AF using the M1d Content Hosting Provisioning API specified in clauses 4.3.3 and 7.5 of ETSI TS 126 512 [i.7]. The ingest configuration indicates that the Media Player Entry document is available from the DVB-DASH MPD Server and that the corresponding content is available to be pulled from the DVB-DASH Segment Server. Each distribution configuration may reference a server certificate provisioned in the previous step.
- Step 6: As a consequence of each distribution configuration provisioned in the previous step referencing a server certificate, the 5GMSd AF configures the 5GMSd AS with the referenced server certificate(s) via reference point M3d.

NOTE: ETSI TS 126 512 [i.7] does not specify an API at reference point M3d in Release 16.

Step 7: The 5GMSd AF configures the 5GMSd AS with the Content Hosting Configuration via reference point M3d.

5G Media Streaming services for the selected DVB-I services are now provisioned.

### 6.3.3.2 Service discovery procedure

The procedures that a DVB-I Client uses to discover the set of available DVB-I services are depicted in figure 6.3.3.2-1. This realizes the M8d service announcement procedure in the context of 5G Media Streaming.

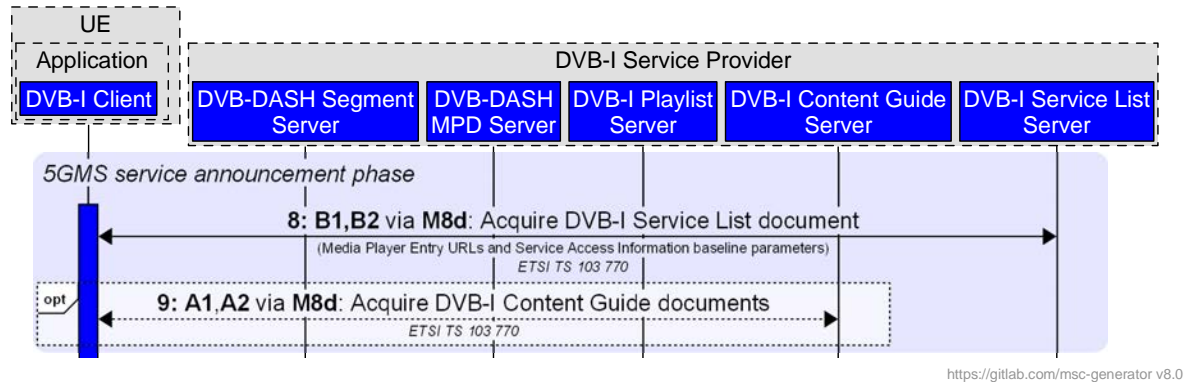

**Figure 6.3.3.2-1: Call flow sequence for discovering DVB-I services**

The discovery steps are as follows:

Step 8: The DVB-I Client acquires the DVB-I Service List document from the DVB-I Service List Server using interactions B1 and B2 as specified in clauses 5 and 7.1.1 of ETSI TS 103 770 [i.21]. All service instances appearing in the DVB-I Service List with a **DASHDeliveryParameters** element are available via unicast and (unless a DVB-I Playlist document is referenced) the URL of the Media Player Entry document for the corresponding 5GMS service (in this case, a DVB-DASH MPD) is carried in the **DASHDeliveryParameters/UriBasedLocation** element, as specified in clause 5.2.7.2 of ETSI TS 103 770 [i.21].

Each service instance in the DVB-I Service List plays the role here of a Service Announcement at reference point M8d. As a consequence, the DVB-I Service List document needs to convey at minimum the baseline Service Access Information parameters, namely the available 5GMSd AF host address(es) and the Provisioning Session identifier of the 5GMSd downlink streaming service corresponding to the DVB-I service. These parameters are subsequently used by the Media Session Handler to request Service Access Information from a 5GMSd AF (see step 17 below).

NOTE: The annotation of a DVB-I service instance with 5GMS baseline Service Access Information parameters is identified as a gap in clause 6.3.4 of the present document.

Step 9: The DVB-I Client may additionally acquire DVB-I Content Guide documents from the DVB-I Content Guide Server using interactions A1 and A2 as specified in clause 6 of ETSI TS 103 770 [i.21].

### 6.3.3.3 Service selection procedure

The procedures that a 5G Broadcast TV/Radio Service Application uses to select and play back a DVB-I service that has been made available via 5G Broadcast for presentation are depicted in figures 6.3.3.3-1 and 6.3.3.3-2.

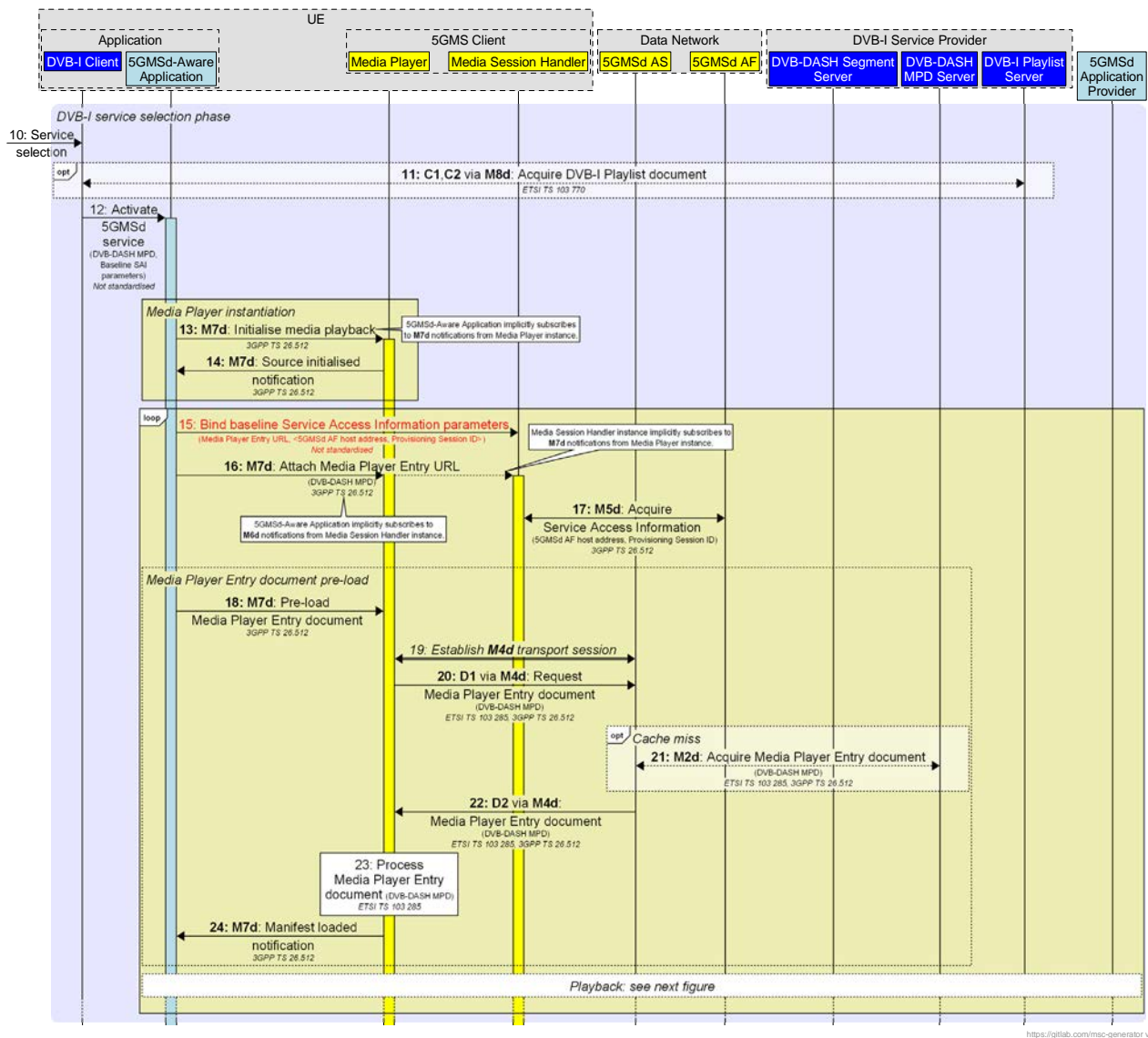

**Figure 6.3.3.3-1: Call flow sequence for DVB-I service selection**

When a DVB-I service available via 5G Media Streaming is selected for presentation (e.g. as a result of a user interaction with the DVB-I Client), the steps are as follows:

- Step 10: The end user selects a DVB-I service in the user interface of the Application.
- Step 11: If present in the corresponding DVB-I service instance, the DVB-I Client acquires a DVB-I Playlist document from the DVB-I Playlist Server using interactions C1 and C2 as specified in clauses 5.2.7 and 7.1.1 of ETSI TS 103 770 [i.21].

Each **PlayListEntry** in the DVB-I Playlist document that corresponds to a service provisioned for 5G Media Streaming needs to convey at minimum the baseline Service Access Information parameters (i.e. the 5GMSd AF host addresses and the Provisioning Session identifier of the 5GMSd downlink streaming service) corresponding to the playlist entry. These parameters are subsequently used by the Media Session Handler to request Service Access Information from the 5GMSd AF (see step 17 below).

NOTE 1: The annotation of a DVB-I Playlist entry with 5GMS baseline Service Access Information parameters is identified as a gap in clause 6.3.4 of the present document.

Step 12: The DVB-I Client invokes the 5GMSd-Aware Application, passing the URL of a Media Player Entry document (i.e. a DVB DASH MPD) as a parameter. This is either the URL of a presentation manifest selected from the DVB-I Playlist document in the previous optional step or else the contents of the `DASHDeliveryParameters/UriBasedLocation` element of the selected DVB-I service instance. The baseline Service Access Information parameters (including the 5GMSd AF host addresses and the Provisioning Session ID of the 5GMS downlink streaming service) are also passed to the 5GMSd-Aware Application.

NOTE 2: This interaction is internal to the Application and is not standardized.

When the first DVB-I service is selected by the DVB-I Client, a Media Player needs to be instantiated and initialized:

Step 13: The 5GMSd-Aware Application initializes a new instance of the Media Player by invoking the `initialize()` Media Stream Handler API method specified in clause 13.2.3.2 of ETSI TS 126 512 [i.7].

As a side-effect of the method invocation, the 5GMS-Aware Application is implicitly subscribed to receiving M7d notifications from the Media Player instance.

Step 14: In response, the Media Player sends a `SOURCE_INITIALIZED` notification at reference point M7d, as specified in clause 13.2.5 of ETSI TS 126 512 [i.7].

The following steps are followed whenever a DVB-I service has been (re)selected:

Step 15: The 5GMS-Aware Application configures a binding in the Media Session Handler configuration between the parameters passed in step 12: the Media Player Entry URL (or a prefix of that URL) and the baseline Service Access Information parameters (the 5GMSd AF host addresses and the Provisioning Session ID of the 5GMS downlink streaming service).

NOTE 3: This binding is not currently specified in the Media Session Handler model in clause 12.2.2 of ETSI TS 126 512 [i.7]. This gap is recorded in clause 6.3.4 of the present document.

Step 16: Using the Media Player Entry URL passed in step 12, the 5GMSd-Aware Application sets the Media Entry Point URL in the Media Player instance by invoking the `attach()` Media Stream Handler API method specified in clause 13.2.3.3 of ETSI TS 126 512 [i.7].

As a side-effect of this step, the Media Session Handler is also initialized with the Media Player Entry URL. The Media Session Handler is implicitly subscribed to receiving M7d notifications from the Media Player instance. And the 5GMS-Aware Application is implicitly subscribed to receiving M6d notifications from the Media Session Handler instance.

NOTE 4: Although recorded as a potential gap in clause 6.3.4 of the present document, the means to achieve this initialization of the Media Session Handler is implementation-specific.

Step 17: As a consequence of its initialization in the previous step, the Media Session Handler uses the Media Player Entry URL to dereference the binding configured in step 15 and thereby obtains the baseline Service Access Information parameters (the 5GMSd AF host addresses and the Provisioning Session ID of the 5GMS downlink streaming service). It uses these to request Service Access Information from a 5GMSd AF instance at reference point M5d (see clauses 4.7.2 and 11.2 of ETSI TS 126 512 [i.7]) for the Provisioning Session corresponding to the selected DVB-I service.

NOTE 5: Although this step is optional in the general case of downlink 5G Media Streaming, in this scenario it is essential for the later invocation of the Media Session Handling APIs.

At this point, the Media Player may be instructed to pre-load the Media Player Entry document:

Step 18: The 5GMSd-Aware Application requests the Media Player instance to pre-load the Media Player Entry document (DVB-DASH MPD) by invoking the `preload()` Media Stream Handler API method specified in clause 13.2.3.4 of ETSI TS 126 512 [i.7].

Step 19: The Media Player establishes a transport session at reference point M4d with the 5GMSd AS.

NOTE 6: The Media Session Handling API defined at reference point M7d in clause 13.2 of ETSI TS 126 512 [i.7] does not expose the transport parameters selected for use at reference point M4d. However, this is not considered to be a significant gap in the context of this scenario and is therefore not recorded in clause 6.3.4 of the present document.

- Step 20: The Media Player attempts to acquire the Media Entry Point document (DVB-DASH MPD) from the 5GMSd AS at reference point M4d according to interaction D1, as specified in clause 6 of ETSI TS 103 770 [i.21].
- Step 21: If the 5GMS AS does not have a cached copy of the requested Media Entry Point document (DVB-DASH MPD), it acquires one from the DVB-DASH MPD Server as specified in ETSI TS 103 285 [i.22].
- Step 22: The requested Media Entry Point document is returned by the 5GMSd AS to the requesting Media Player at reference point M4d according to interaction D2, as specified in clause 6 of ETSI TS 103 770 [i.21].
- Step 23: The Media Player processes the Media Entry Point document (DVB-DASH MPD) returned in the previous step. The Media Player stores any Service Descriptions from the Media Entry Point document in its internal state ready to be queried by the 5GMS-Aware Application. Depending on its configuration, the Media Player may at this point establish the collection and logging of metrics.
- Step 24: On success, the Media Player sends a *MANIFEST\_LOADED* notification to the 5GMSd-Aware Application at reference point M7d, as specified in clause 13.2.5 of ETSI TS 126 512 [i.7].

The call flow continues as shown in figure 6.3.3.3-2 with the initiation of media playback:

- Step 25: The 5GMSd-Aware Application requests the Media Player instance to start playback by invoking the *play()* Media Stream Handler method specified in clause 13.2.3.5 of ETSI TS 126 512 [i.7].
- Step 26: If required by the Media Player Entry document, the Media Player instance acquires a DRM licence.
- Step 27: The Media Player configures its rendering pipeline.

The Media Player instance acquires the initialization segment(s) referenced by the current Media Entry Point document (DVB-DASH MPD):

- Step 28: The Media Player attempts to acquire an initialization segment from the 5GMSd AS at reference point M4d according to interaction E1, as specified in clause 6 of ETSI TS 103 770 [i.21].
- Step 29: If the 5GMS AS does not have a cached copy of the requested initialization segment, it acquires one from the DVB-DASH Segment Server as specified in ETSI TS 104 285 [i.22].
- Step 30: The requested initialization segment is returned by the 5GMSd AS to the requesting Media Player at reference point M4d according to interaction E2, as specified in clause 6 of ETSI TS 103 770 [i.21].
- Step 31: The Media Session Handler receives a *PLAYBACK\_PLAYING* notification from the Media Player via reference point M7d, as specified in clause 13.2.5 of ETSI TS 126 512 [i.7].

NOTE 7: This notification is sent by the Media Player whenever the playback state changes. At other times, the current state of the Media Player may be determined by interrogating the Media Stream Handler status information exposed via reference point M7d, as specified in clause 13.2.6 of ETSI TS 126 512 [i.7] (see step 40 below).

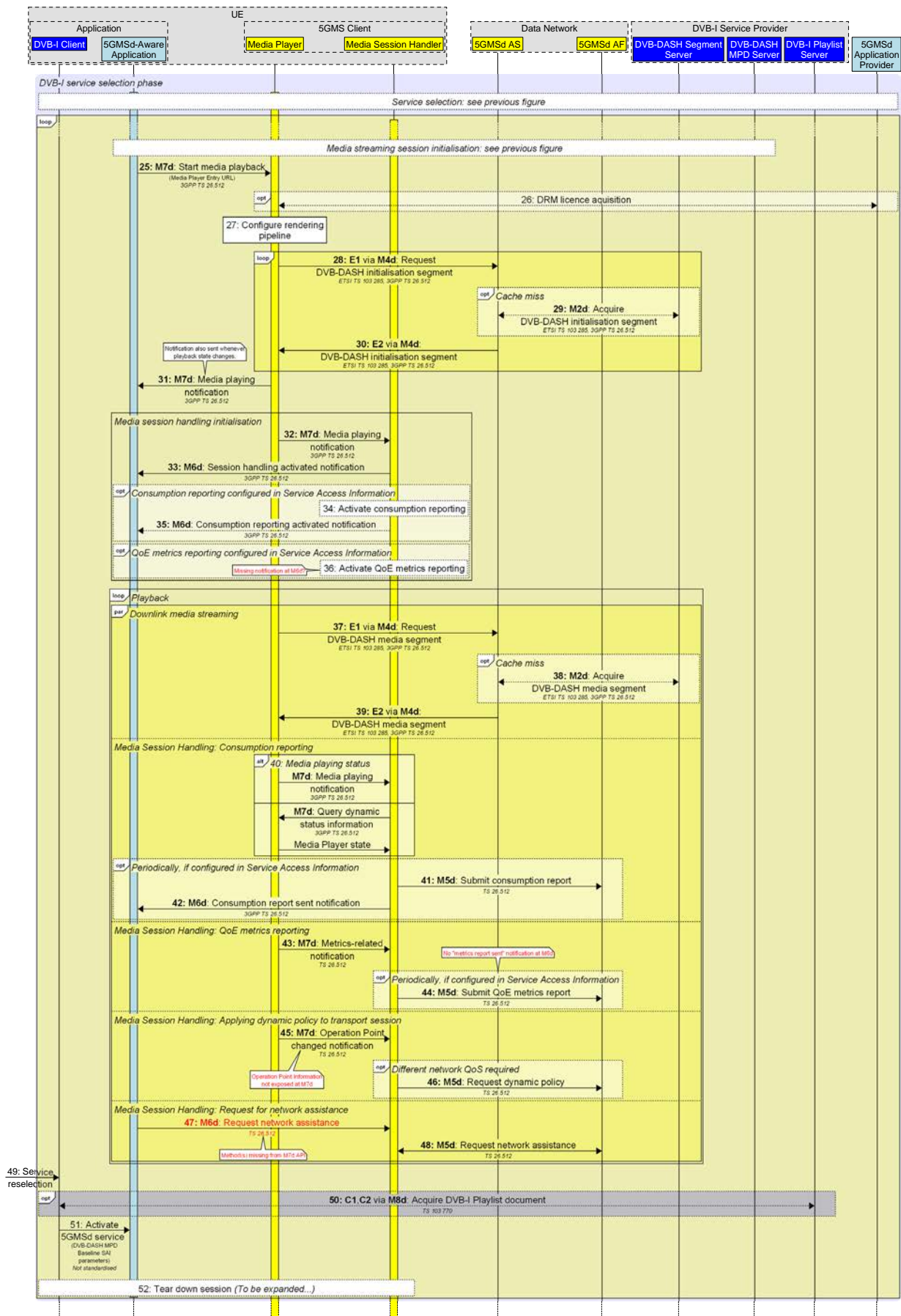

Figure 6.3.3-2: Call flow sequence for DVB-I service selection (continued)

Once the Media Player is ready to start playback, media session handling is activated:

- Step 32: The Media Player sends a *PLAYBACK\_PLAYING* notification to the Media Session Handler via reference point M7d, as specified in clause 13.2.5 of ETSI TS 126 512 [i.7].
- Step 33: In response, the Media Session Handler sends a *SESSION\_HANDLING\_ACTIVATED* notification to the 5GMS-Aware Application, as specified in clause 12.2.3 of ETSI TS 126 512 [i.7].
- Step 34: If configured in the Service Access Information, the Media Session Handler initiates consumption reporting...
- Step 35: ...and sends a *CONSUMPTION\_REPORTING\_ACTIVATED* notification to the 5GMS-Aware Application informing it, as specified in clause 12.2.6 of ETSI TS 126 512 [i.7].
- Step 36: If configured in the Service Access Information, the Media Session Handler initiates QoE metrics reporting.

NOTE 8: There is no notification defined at reference point M6d to announce the successful activation of QoE metrics reporting (c.f. the previous step announcing the activation of consumption reporting). This gap is recorded in clause 6.3.4 of the present document.

The Media Player instance acquires the media segment(s) according to the presentation described by the current Media Entry Point document (DVB-DASH MPD):

- Step 37: The Media Player attempts acquire a media segment from the 5GMSd AS at reference point M4d according to interaction E1, as specified in clause 6 of ETSI TS 103 770 [i.21].
- Step 38: If the 5GMS AS does not have a cached copy of the requested media segment, it acquires one from the DVB-DASH Segment Server as specified in ETSI TS 103 285 [i.22].
- Step 39: The requested media segment is returned by the 5GMSd AS to the requesting Media Player at reference point M4d according to interaction E2, as specified in clause 6 of ETSI TS 103 770 [i.21].

In parallel with media streaming and playback, the Media Session Handler interacts with the 5GMSd AF at reference point M5d to invoke various Media Session Handling APIs:

- Step 40: The Media Session Handler receives a playback status change notification (e.g. *PLAYBACK\_PLAYING* or *PLAYBACK\_PAUSED*) from the Media Player via reference point M7d, as specified in clause 13.2.5 of ETSI TS 126 512 [i.7] or the Media Session Handler queries the Media Player's current playback status by inspecting the dynamic status information exposed by it at reference point M7d, as specified in clause 13.2.6 of ETSI TS 126 512 [i.7].

NOTE 9: The means to interrogate the Media Player's current playback status is currently missing from the M7d dynamic status information. This is recorded as a gap in clause 6.3.4 of the present document.

- Step 41: If provisioned, media consumption is reported periodically by the Media Session Handler to the 5GMSd AF, as specified in clauses 4.7.4 and 11.3 of ETSI TS 126 512 [i.7]. For efficiency of transmission, the consumption report summarizes the playback status information into consumption reporting units, as specified in clause 11.3.3 of ETSI TS 126 512 [i.7]. The reporting interval is determined by the consumption reporting configuration included in the Service Access Information acquired by the Media Session Handler in step 16.
- Step 42: Whenever a consumption report is successfully sent to the 5GMSd AF, the Media Session Handler sends a *NEW\_CONSUMPTION\_REPORT* notification via M6d, as specified in clause 12.2.6 of ETSI TS 126 512 [i.7].
- Step 43: The Media Session Handler receives various *METRIC\_ADDED*, *METRIC\_CHANGED*, *METRIC\_UPDATED* and *METRICS\_CHANGED* notifications from the Media Player via reference point M7d, as specified in clause 13.2.5 of ETSI TS 126 512 [i.7].



Step 44: If provisioned, QoE metrics are reported periodically by the Media Session Handler to the 5GMSd AF, as specified in clauses 4.7.5 and 11.4 of ETSI TS 126 512 [i.7]. For efficiency of transmission, the metrics report summarizes multiple metric values. The reporting interval and the set of metrics to be reported is determined by the metrics reporting configuration included in the Service Access Information acquired by the Media Session Handler in step 16.

NOTE 10: There is no notification defined at reference point M6d to announce the successful submission of a QoE metrics report to the 5GMSd AF (c.f. step 42 announcing the successful submission of a consumption report). This gap is recorded in clause 6.3.4 of the present document.

Step 45: The Media Session Handler receive an *OPERATION\_POINT\_CHANGED* notification from the Media Player via reference point M7d, as specified in clause 13.2.5 of ETSI TS 126 512 [i.7]. Details of the currently selected Service Operation Point are provided by the Media Player in Operation Point Information.

NOTE 11: ETSI TS 126 512 [i.7] does not currently specify that Operation Point Information is provided as a payload of the *OPERATION\_POINT\_CHANGED* notification event. Nor does it specify a means to interrogate the currently selected Service Operation Point in the dynamic status information exposed by the Media Player at reference point M6d. Also, the Operation Point Information does not currently include the external reference quoted in the MPEG-DASH MPD for each Representation. These gaps is recorded in clause 6.3.4 of the present document.

Step 46: Dynamic policies are invoked by the Media Session Handler requesting that the 5GMSd AF instantiates one of the Policy Templates advertised in the Dynamic Policy Invocation Configuration of the Service Access Information acquired in step 17. This maps an opaque external reference to a Policy Template ID. 5GMS Provisioning Session, as specified in clauses 4.7.3 and 11.5 of ETSI TS 126 512 [i.7]. (This step is only necessary if the newly selected Service Operation Point requires a different network QoS from the previously selected one.)

Step 47: The 5GMSd-Aware Application requests network assistance from the Media Session Handler. For example, the 5GMSd-Aware Application may request a download boost because it has noticed that the Media Player's buffer fill level has become dangerously low.

NOTE 12: ETSI TS 126 512 [i.7] does not currently specify a client API at reference point M7d to request network assistance. This gap is recorded in clause 6.3.4 of the present document.

Step 48: Network assistance is invoked by the Media Session Handler on the 5GMSd AF, as specified in clauses 4.7.3 and 11.5 of ETSI TS 126 512 [i.7].

Playback of the selected DVB-I service continues until further user interaction.

#### 6.3.3.4 Service reselection procedure

The call flow for service reselection is for future study.

### 6.3.4 Identified gaps in existing DVB/3GPP/ETSI specifications

The following gaps are identified in existing specifications in relation to this scenario:

- 1) With reference to step 8 in clause 6.3.3.2 of the present document, DVB-I service instance metadata needs to be extended to include baseline 5GMS Service Access Information parameters. This could, for example, be achieved as a new 5G Media Streaming delivery parameters element (e.g. **5GMSServiceAccessInformationLocator**) used in conjunction with the existing **DASHDeliveryParameters** element in ETSI TS 103 770 [i.21]. In addition, or alternatively, the extension could be specified in ETSI TS 126 501 [i.6] and ETSI TS 126 512 [i.7].

The 5GMS AF host address and Provisioning Session ID are most conveniently combined into a simple M5 Service Access Information request URL string. Because the Service Access Information may be available from more than one 5GMSd AF instance in a 5GMS System deployment, the extended DVB-I Service List schema should allow zero or more such elements to be present in the **DASHDeliveryParameters** parent element.

- 2) With reference to step 11 in clause 6.3.3.3 of the present document, the DVB-I Playlist entry element needs to be extended to include baseline 5GMS Service Access Information parameters. This could, for example, be achieved as additional attributes of the **PlaylistEntry** element in ETSI TS 103 770 [i.21]. In addition, or alternatively, the extension could be specified in ETSI TS 126 501 [i.6] and ETSI TS 126 512 [i.7].

The 5GMS AF host address and Provisioning Session ID are most conveniently combined into a simple M5 Service Access Information request URL string. Because the Service Access Information may be available from more than one 5GMSd AF instance in a 5GMS System deployment, the extended DVB-I Playlist schema should allow zero or more such URLs to be listed against each playlist entry.

- 3) With reference to step 15 in clause 6.3.3.3 of the present document, the Media Session Handler API at reference point M7 (see clause 13.2.3 of ETSI TS 126 512 [i.7]) does not, at present, provide a means to bind the Media Player Entry URL (i.e. the MPEG-DASH MPD URL) to the Service Access Information parameters. This gap could be closed by extending the relevant high-level call flow(s) in ETSI TS 126 501 [i.6] and by specifying an additional method in the M7 API in ETSI TS 126 512 [i.7].
- 4) With reference to step 16 in clause 6.3.3.3 of the present document, ETSI TS 126 512 [i.7] does not currently specify a mechanism for implicitly launching the Media Session Handler when a service is selected (see clause 6.3.3.3). However, this is assumed to be implementation-dependent and therefore does not need to be addressed by technical specification.
- 5) With reference to step 36 in clause 6.3.3.3 of the present document, ETSI TS 126 512 [i.7] does not currently specify a notification event at reference point M6d to announce the successful activation of QoE metrics reporting by the Media Session Handler to M6d API consumers such as the 5GMSd-Aware Application. This could be added in clause 12.2.7 of ETSI TS 126 512 [i.7] along similar lines to the specification of consumption reporting notification events in clause 12.2.6 ETSI TS 126 512 [i.7].
- 6) With reference to step 40 in clause 6.3.3.3 of the present document, the Media Stream Handler status information exposed at reference point M7 (see clause 13.2.6 of ETSI TS 126 512 [i.7]) does not explicitly include the current media playback status of the Media Player. The status can be inferred from a non-zero value of the playback rate property, but it would be better to explicitly expose the states of enumerated in table 13.2.2-1 of ETSI TS 126 512 [i.7] in the status information.
- 7) With reference to step 44 in clause 6.3.3.3 of the present document, ETSI TS 126 512 [i.7] does not currently specify a notification event at reference point M6d to announce the successful submission of a QoE metrics report by the Media Session Handler to the 5GMSd AF. This could be added in clause 12.2.7 of ETSI TS 126 512 [i.7] along similar lines to the specification of consumption reporting notification events in clause 12.2.6.
- 8) With reference to step 45 in clause 6.3.3.3 of the present document, the *OPERATION\_POINT\_CHANGED* notification event (see clause 13.2.5 of ETSI TS 126 512 [i.7]) does not currently specify that Operation Point Information is provided as its payload. Nor is the Operation Point Information of the currently selected Service Operation Point included in the dynamic status information exposed by the Media Player at reference point M7d (see clause 13.2.6 of ETSI TS 126 512 [i.7]). Either (or both) of these gaps need to be closed in order for the Media Session Handler to select an appropriate dynamic policy template that satisfies the Service Operation Point selected by the Media Player.

In addition, the Operation Point Information does not include the external reference used to correlate it with a Representation in the MPEG-DASH MPD. This gap needs to be closed in order for the Media Session Handler to select an appropriate dynamic policy template that satisfies the Service Operation Point selected by the Media Player.

- 9) With reference to step 47 in clause 6.3.3.3 of the present document, ETSI TS 126 512 [i.7] does not currently specify a client API at reference point M6d for the 5GMS-Aware Application or Media Player to request network assistance from the Media Session Handler. Suitable methods could be specified in the (currently empty) clause 12.2.5 of ETSI TS 126 512 [i.7] to close this gap.

NOTE: Clause 12.2 of ETSI TS 126 512 [i.7] is currently narrowly scoped to apply to downlink media streaming only. Any new methods should be designed to work for uplink media streaming as well as downlink media streaming.

## 6.4 DVB-I service offerings simultaneously over broadcast and unicast

### 6.4.1 Description

In DVB BlueBook C100 [i.1], the same three use cases motivate specifications for the delivery of DVB-I service offerings simultaneously over 5G broadcast and unicast, namely:

- Use Case 2 (5G Broadcast/Unicast hybrid delivery to handheld devices) in clause 5.3 of [i.1];
- Use Case 3 (5G Broadcast standalone with Unicast for EPG) in clause 5.4 of [i.1]; and
- Use Case 6 (DVB-I Hybrid Service over 5G) in clause 5.7 of [i.1].

Relevant commercial requirements indicated in *italics* are copied from [i.1] below as follows:

**Table 6.4.1-1: Relevant Commercial Requirements reproduced from DVB BlueBook C100 [i.1]**

<ul style="list-style-type: none"> <li>• <i>"Req 2.2.3: DVB shall provide specifications to enable a basic DVB-I service to be delivered over regular unicast and 5G Broadcast and 5G Media Streaming at the same time as independent service instances. Service instances may be provided with different quality (e.g. bit rate, end-to-end latency, channel switch times, etc.)."</i></li> <li>• <i>Req 2.2.4: DVB shall provide specifications to enable hybrid DVB-I services using 5G Delivery Networks, defined as</i> <ul style="list-style-type: none"> <li>- <i>the DVB-I service is described in a DVB-I service list</i></li> <li>- <i>a basic DVB-I service is distributed via 5G Broadcast</i></li> <li>- <i>the service is augmented by ordinary unicast or 5G Media Streaming</i></li> </ul> </li> <li>• <i>Req 2.4.9 DVB specifications shall allow the disambiguation of editorially identical DVB-I service instances delivered over different delivery networks (including 5G Delivery Networks) from a Service Instance delivered via OTT unicast.</i></li> <li>• <i>Req 2.4.10: DVB specifications shall allow a DVB-I client to unambiguously identify a specific DVB I editorial service (i.e. a service which carries specific editorial content) received over 5G Broadcast or 5G Media Streaming based on radio layer access parameters (e.g. frequency + TMGI/service identifier for 5G Broadcast), in a similar way as can be done on DVB broadcast networks (i.e. DVB triplet, orbital position/frequency, etc.).</i></li> <li>• <i>Req 2.4.12: The DVB-I specification shall provide information for 5G service instance to allow a client or gateway to select the best delivery mode.</i></li> <li>• <i>Req 2.5.4: DVB specifications shall provide the means to offer a basic service over a 5G Broadcast System for which certain components are only provided over a unicast-delivered signal (for example subtitles, or metadata).</i></li> <li>• <i>Req 2.5.5: DVB specifications shall provide the means to offer a basic service over a 5G Broadcast System for which certain components are replaced by a unicast-delivered signal (for example an alternative language or an alternative view).</i></li> <li>• <i>Req 2.5.6 DVB specifications shall provide the means to offer a basic service over a 5G Broadcast System for which unicast-based content and ad insertion/replacement (targeted to users, regions, etc.) is enabled and the client, depending on its capabilities, makes use of the unicast provisioned content.</i></li> <li>• <i>Req 2.5.7 DVB specifications shall provide the means to offer a basic service over a 5G Broadcast System for which certain components are augmented by a unicast-delivered signal (for example an enhancement layer).</i></li> <li>• <i>Req 2.5.8 DVB specifications shall provide the means to offer a basic service over a 5G Broadcast System which is accessible over unicast for time-shifted viewing and permits near seamless transition between the live linear and timeshifted consumption modes.</i></li> <li>• <i>Req 2.5.9 DVB specifications shall provide the means to offer a basic service over a 5G Broadcast System with fast startup while maintaining efficient delivery, possibly using unicast delivery.</i></li> <li>• <i>Req 2.6.5 DVB specifications shall enable the possibility to ensure proper time alignment in time of DVB-DASH-based DVB I service instances carried over different delivery networks (including 5G Delivery Networks), so that switching between them can be perceived as reasonably seamless.</i></li> <li>• <i>Req 2.6.14 DVB should provide specifications to enable hybrid DVB-I services with unicast-based error recovery if reception on a primary 5G Broadcast System is lossy.</i></li> <li>• <i>Req 2.7.10 DVB shall provide specifications to enable hybrid DVB-I services with DVB-DASH metrics reporting."</i></li> </ul>
<p>NOTE: Modal verbs appearing in this table are non-normative in the context of the present document.</p>

As can be seen from the use cases and requirements, quite different flavours of unicast and broadcast mixed services exist. A subset of potential use cases is documented in more details in the following:

- *DVB-I via unicast and DVB-DASH via 5G Broadcast*: DVB-I Service metadata is retrieved via unicast and DVB-DASH content is transmitted via 5G Broadcast. This scenario is described in clause 6.4.3.
- *Hybrid broadcast-unicast services with session continuity*: The same DVB-DASH service is made available via both unicast and 5G Broadcast delivery networks, but only one Representation of each Adaptation Set in DVB-DASH is provided via 5G Broadcast. When the receiver is in 5G Broadcast reception, it consumes the broadcast content. When out of coverage, it uses unicast with DASH adaptive streaming. This scenario is described in clause 6.4.4.3.
- *Hybrid broadcast-unicast services for time-shifted viewing*: The service is made available via both unicast and 5G Broadcast delivery networks, but only one Representation of each Adaptation Set is provided via 5G Broadcast. The content is retained on unicast for a period of time to support time shifted access. This scenario is described in clause 6.4.4.4.
- *Hybrid broadcast-unicast services with content or component replacement*: The service is made available via both unicast and 5G Broadcast delivery networks, but only one Representation of selected Adaptation Sets is provided via 5G Broadcast. Some Adaptation Sets are only available via unicast. In another case, two or more content alternatives may exist for a period of time, but only one alternative is provided over 5G Broadcast. Based on the selection of the client, the receiver collects the content from broadcast, if available or otherwise from unicast. This scenario is described in clause 6.4.4.3.4.

## 6.4.2 Generic architecture

Based on the above description and requirements as well as the technology introduction in clause 4, this clause provides a possible generic deployment architecture for "DVB-I service offerings simultaneously over broadcast and unicast" shown in figure 6.4.2-1.

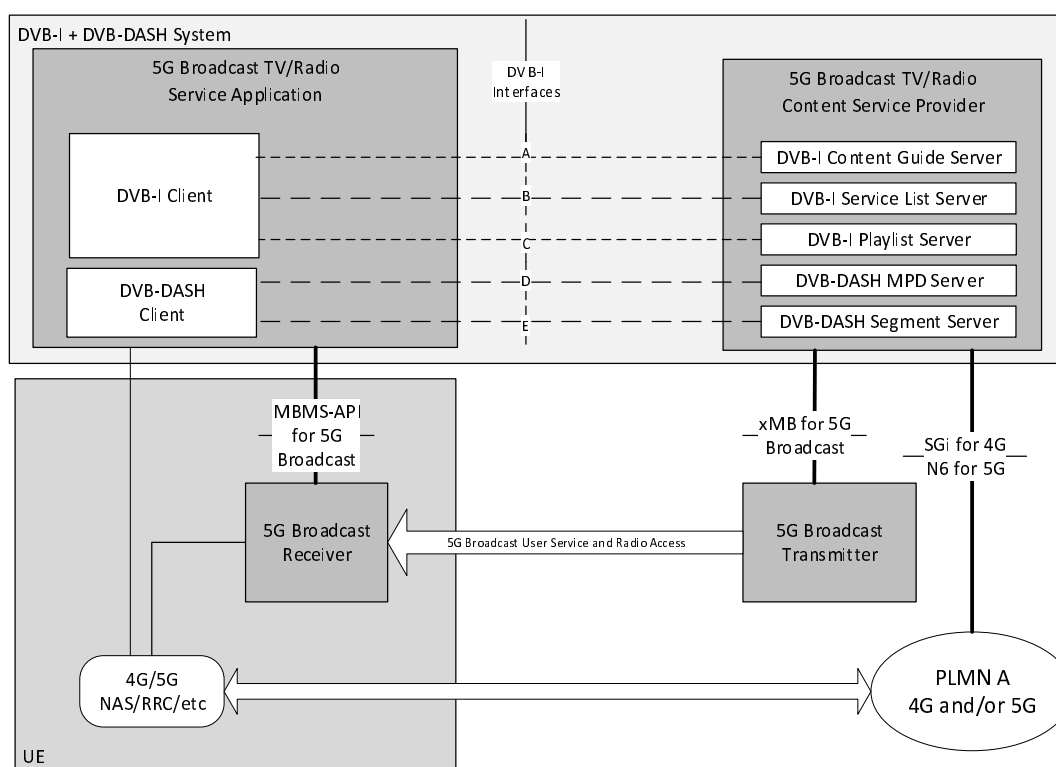

Figure 6.4.2-1: Basic architecture for DVB-I and DVB-DASH via 5G Broadcast and unicast

Again, the DVB-I + DVB-DASH System makes use of the 5G Broadcast System in this scenario. Specifically in this architecture, the following assumptions are made:

- The 5G Broadcast TV/Radio Content Service Provider runs DVB-I Service List Server, DVB-I Playlist Server, DVB-DASH MPD Server as well as DVB-DASH Segment Server.
- The 5G Broadcast TV/Radio Content Service application includes a DVB-DASH client as well as a DVB-I Client which deals with Playlist and Service List handling.

Hybrid unicast-broadcast service operation is documented in an informative manner in clause 9 of ETSI TS 103 720 [i.8]. Figure 9.2-1 of [i.2] provides the basic principles of such an operation. Figure 6.4.2-1 above is an adaptation of this figure by adding DVB-I and DVB-DASH on top of the hybrid system. Note that the northbound reference points are referred to as:

- **SGi** for 4G, i.e. the reference point between the Evolved Packet Core (EPC) and the public IP network.
- **N6** for 5G, i.e. the reference point between the User Plane Function (UPF) and the Data Network (DN), i.e. the public Internet.

A regular IP interface to the public Internet is provided by the UE to the 5G Broadcast TV/Radio Content Service application.

## 6.4.3 DVB-I via unicast and DVB-DASH via 5G Broadcast

### 6.4.3.1 Description

In this scenario, DVB-I Service metadata is retrieved via unicast and DVB-DASH content is transmitted via 5G Broadcast. The DVB-I Service operation is unmodified: it operates based on a unicast connection. The Service Provider Management function of the 5G Broadcast TV/Radio Content Service Provider sets up the DASH services to be sent over 5G Broadcast and adds the appropriate signaling to the DVB-I Playlist. The DVB-I Client retrieves DVB-I Service metadata via unicast and provides information to an Application Client alongside which activates reception of DVB-I service instance(s) from 5G Broadcast as required. Such a scenario enables rich DVB-I-based service management, at the same time as efficient delivery of some (or all) DVB-DASH services in the DVB-I service list.

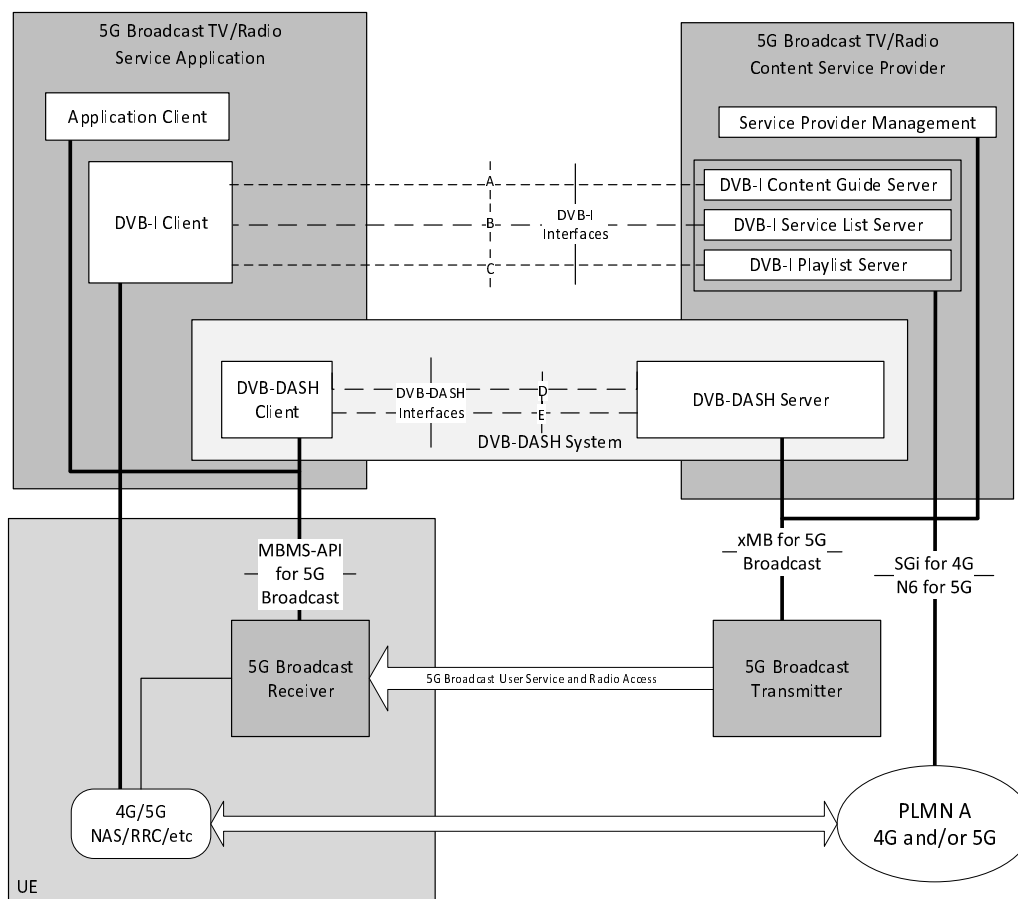

**Figure 6.4.3.1-1 DVB-I unicast with DVB-DASH Broadcast**

Different variations of this scenario are possible:

- The content service provided by DVB-DASH is provisioned exclusively over 5G Broadcast.
- The content service provided by DVB-DASH is provisioned at the same time over 5G Broadcast and regular unicast, modelled as two different DVB-I service instances:
  - Based on the capabilities of the device, the Application Client may decide to select one or the other service instance using information provided in the DVB-I service list. The 5G Broadcast TV/Radio Content Service Provider may signal its preference for one or the other service instance in the DVB-I service list.
  - In the general case, the presentation timelines of the two service instances are not explicitly aligned. If the Application Client decides to switch between service instances, no guarantees on seamless service continuity can be expected.

### 6.4.3.2 Procedures and call flows

The following steps occur in this scenario:

- The DVB-DASH service provisioning is aligned with a subset of the procedures in clause 6.2.3.1:
  - Steps 1-7 apply unmodified for DVB-DASH services.
  - Steps 9 and 10 are omitted because DVB-I service metadata is not distributed via 5G Broadcast.
  - An MBMS Service Announcement is compiled by the BM-SC for each DVB-DASH service provisioned in step 5 above and these are assembled into a User Service Announcement bundle (see ETSI TS 126 346 [i.5]).

- The DVB-DASH service transmission is aligned with a subset of the procedures in clause 6.2.3.2:
  - Step 14 is omitted because DVB-I service metadata is not distributed via 5G Broadcast.
  - Steps 17-18 apply unmodified for DVB-DASH services.
- DVB-I services are discovered using a procedure similar to clause 6.3.3.2 and figure 6.3.3.2-1, but adapted as follows:
  - Steps 8 and 9 are carried out using the client's basic unicast connection to the public IP network at reference point **SGi/N6** in place of 5GMSd reference point **M8d**.
  - The relevant service instances appearing in the DVB-I Service List with a **DASHDeliveryParameters** element are available via 5G Broadcast and the URL (e.g. an MBMS URL) of the Media Entry Point document for the corresponding 5G Broadcast service (in this case, a DVB DASH MPD) is carried in the **DASHDeliveryParameters/UriBasedLocation** element, as specified in clause 5.2.7.2 of ETSI TS 103 770 [i.21].
  - A unicast service instance may additionally be provided in the DVB-I Service List for each DVB-DASH service, as identified in clause 6.4.3.1. In this case, the 5G Broadcast service instance may be signalled with higher priority using the *DVB-I service instance priority attribute* specified in clause 5.5.4 of ETSI TS 103 770 [i.21].
- DVB-I service selection procedures are aligned with clause 6.3.3.3 as well as clause 6.2.3.4. The following adaptations need to be considered:
  - From clause 6.3.3.3, step 10 and step 11 are carried out. In step 11, the DVB-I Playlist document is acquired using the client's basic unicast connection to the public IP network at reference point **SGi/N6** in place of 5GMSd reference point **M8d**.
  - From clause 6.2.3.4, steps 33 to 48 are carried out in an unmodified fashion.

### 6.4.3.3 Potential extensions to existing specifications

It is highly desirable for DVB-I service instances to indicate their availability on unicast or 5G Broadcast to enable a receiver to differentiate them and select the most appropriate DVB-I service instance without further parsing. According to clause 5.5.2 of ETSI TS 103 770 [i.21], a DVB-I Service may be provided based on multiple service instances. All service instances for a given service carry the same editorial content. According to clause 5.5.4 of ETSI TS 103 770 [i.21], a service instance provides delivery parameters, with a choice for, among others, DASH delivery parameters or *other delivery parameters*, the latter for example used to signal an HLS playlist as shown in informative clause G.2.2 of ETSI TS 103 770 [i.21].

To signal a 5G Broadcast service, an additional service instance is used. Two options may be considered:

- 1) The 5G Broadcast service is signalled as a DASH delivery service with an indication that the DASH resources are also available through 5G Broadcast (e.g. by additionally providing the MBMS URL). This option is discouraged as it may result in non-deterministic behaviours for existing DVB-I clients that may assume that all DASH services are unicast.
- 2) The 5G Broadcast service is signalled using a new type of service instance with a new set of service delivery parameters specifically for 5G Broadcast, including the MBMS URL. (This is aligned with the discussion in clause 6.2.4.)

It is highly desirable to decorate DVB-I service instances with an indication of their relative priority (from the content provider's perspective) to drive selection of DVB-I service instances by a receiver, for example to support receiver-initiated failover from a preferred service instance to the next best service instance when the preferred service instance becomes temporarily unavailable. According to clause 5.5.4 of ETSI TS 103 770 [i.21], a service instance can be decorated with a priority to signal such a preference. Service instances do not indicate their availability at specific locations, for example when in 5G Broadcast coverage. While DVB-I supports "Regions", it seems this is for the purpose of channel number ordering, not for service availability. It may be worthwhile to understand the impact to DVB-I service data in case the client is mobile and for example roams across regions.

Time-aligned/identical service instances may be signalled in the DVB-I Service List in order, for example, to allow for seamless transition between different service instances. For more details refer also to clause 6.4.4.

## 6.4.4 Hybrid broadcast-unicast service scenarios

### 6.4.4.1 Description

In this scenario, the same DVB-DASH service is made available concurrently via both unicast and 5G Broadcast delivery networks.

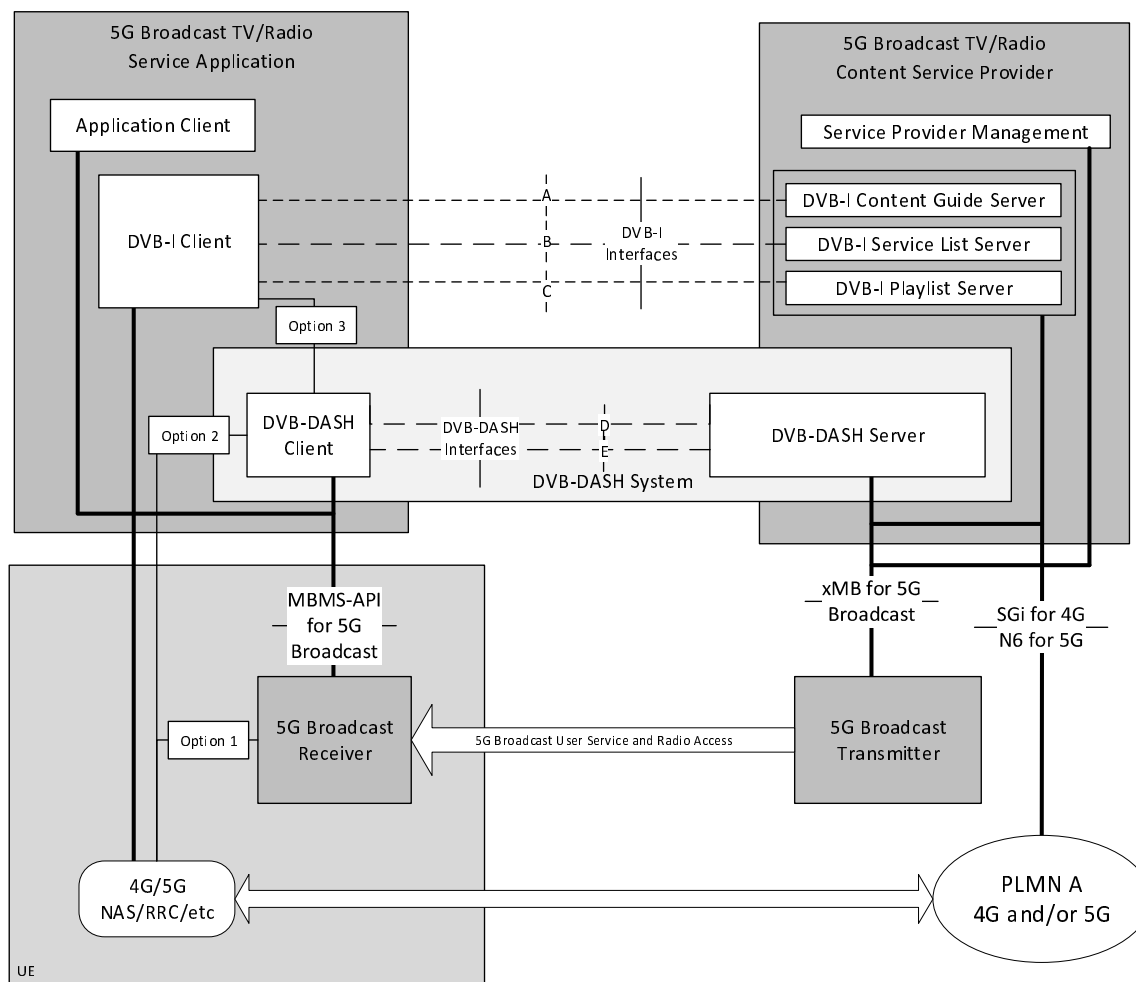

**Figure 6.4.4.1-1: DVB-DASH based service continuity using unicast and broadcast**

Figure 6.4.4.1-1 illustrates three different options for configuration of DVB-I service instances which affect the point in the client devices where the switching decision is made:

- Option 1: *Single service instance with switching handled by 5G Broadcast Receiver:* Hybrid reception is supported by 5G Broadcast and the 5G Broadcast receiver proxies the appropriate handling of unicast and broadcast reception. 5G Broadcast systems and the 5G Broadcast clients support this functionality. A single hybrid DVB-DASH MPD (and updates thereof) is delivered via the 5G Broadcast Receiver. The broadcast and unicast delivery of the same content is abstracted in the hybrid MPD for which at least one Representation is available on broadcast and unicast, differentiated by different base URLs. More details are provided in the remainder of this clause.



- Option 2: *Single service instance switched by DVB-DASH Client:* A single hybrid DVB-DASH MPD (and updates thereof) is delivered via unicast. The MPD models separate broadcast and unicast Representations of the content within the scope of a common parent Adaptation Set, allowing seamless switching between them by the DVB-DASH Client. The different delivery networks are differentiated by different representation Base URLs. The signalling of the availability of networks/service locations described by Base URLs is not defined. However, DVB-DASH defines the ability of attaching priorities to Base URLs as well as client failover behaviour making use of redundant content offering. The applicability of this signalling and the client behaviour for hybrid 5G Broadcast operation is unknown and for further study.
- Option 3: *Two seamlessly switchable DVB-I service instances switched by DVB-DASH Client:* The content is made available as two different DVB-DASH service instances in the DVB-I Service List (as described in clause 6.4.3), but in addition the service instances are timeline-aligned such that the DVB-DASH Client may seamlessly switch between the two service instances based on availability. Each service instance is described by its own DVB-DASH MPD, both of which are handled acquired by the DVB-I Client to enable switching.

The focus in clauses 6.4.4.2 and 6.4.4.3 is on procedures and call flows for hybrid option 1 only. However, in clause 6.4.4.4, some potential updates to DVB-DASH and DVB-I are discussed that may be addressed in order to support hybrid option 2 and hybrid option 3.

#### 6.4.4.2 Procedures and call flows for Option 1

In a service offering as assumed in option 1, the DASH MPD is provided as application service entry point in the MBMS user service announcement. The DASH MPD is delivered as a metadata unit within the user service description. Within the MPD, the resources delivered/available on either unicast or broadcast are differentiated in the delivery MPD as different service locations, typically signalled by different Base URLs in the DVB-DASH MPD. The 5G Broadcast receiver should use one of the methods defined in ETSI TS 126 347 [i.4], clause 7.4, i.e. it implements:

- The functions of a DASH server as defined in clause 7.4.2 of ETSI TS 126 347 [i.4]. In this case the MPD would be rewritten to only offer content that is available to the DASH client.
- The functions of a DASH-Aware Network Element (DANE) for SAND4M mode as defined in clause 7.4.3 of ETSI TS 126 347 [i.4]. In the case, MPD requests are augmented to steer the DASH client to specific delivery networks.

In both cases, only MPD requests and 5G Broadcast delivered requests may be proxied through the 5G Broadcast receiver, whereas unicast Segment requests may directly be resolved by the DVB-DASH client from the DVB-DASH server. In collaboration with the 5G Broadcast Client, the DVB-DASH Client dynamically selects the delivery network from which to acquire media content according to reception conditions, user preferences or other policies. Content is provisioned such that the DVB-DASH Client is able to provide a seamless user experience when switching between different delivery networks. Policies may include to force the DVB-DASH client to use broadcast, when available, or allow the DASH client to choose among content on unicast only, for example for higher quality or for a specific language.

The call flow in figures 6.4.4.2-1, 6.4.4.2-2 and 6.4.4.2-3 provide a generic case for provisioning content from different delivery networks and particularly explain the service continuity scenario.

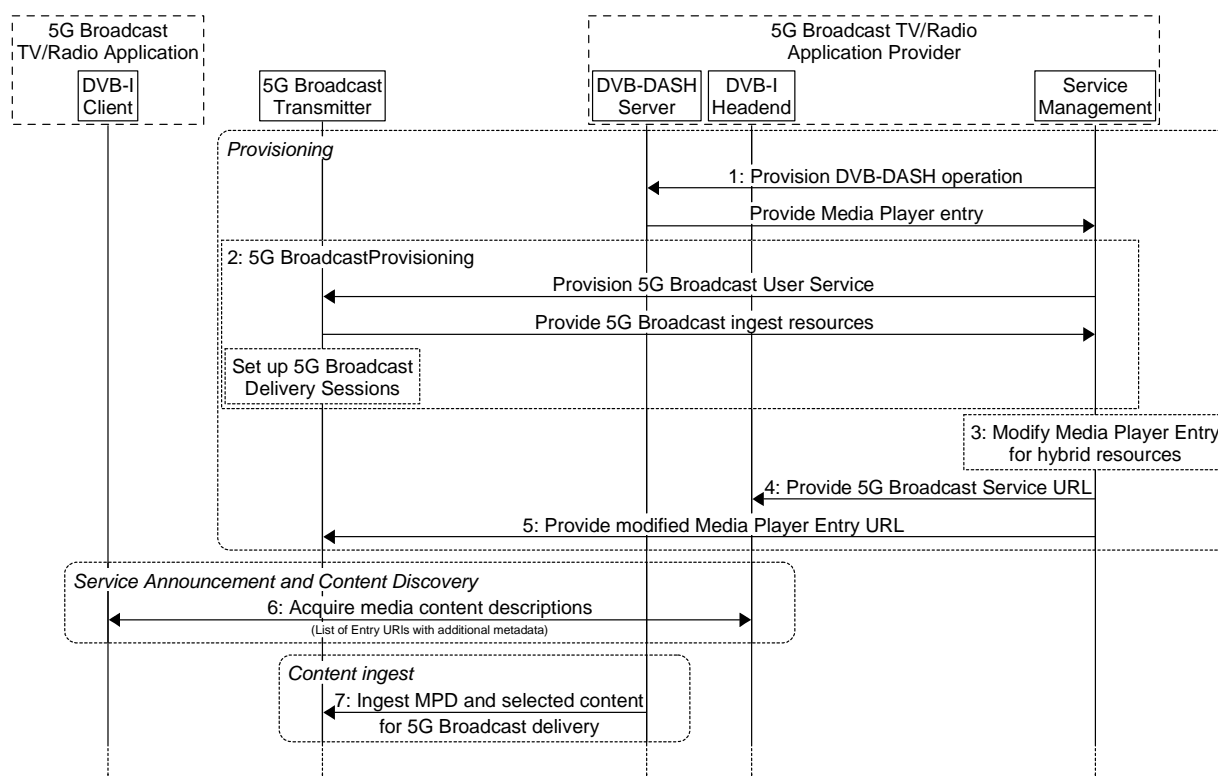

**Figure 6.4.4.2-1: Hybrid broadcast-unicast delivery - Provisioning stage**

- Step 1: The Service Provider Management function provisions distribution of the media content DVB-DASH service and receives a Media Entry Point document in return.
- Step 2: Based on this information, the Service Provider Management function also provisions 5G Broadcast delivery of the hybrid DVB-DASH service. The 5G Broadcast Delivery Session is set up and the BM-SC informs the Service Provider Management function about the content ingest endpoints on the BM-SC.
- Step 3: The Service Provider Management function modifies the Media Entry Point document (in this scenario a DVB-DASH MPD) for hybrid operation, i.e. it selects the content that is provided via 5G Broadcast and what is provided through unicast.
- Step 4: The modified hybrid MPD is provided to the 5G Broadcast transmitter.
- Step 5: The URL of the 5G Broadcast service is provided to the DVB-I server.
- Step 6: The media content is announced to the DVB-I Client in the DVB-I Service List.  
The DVB-I Client acquires the MBMS service entry for the service.
- Step 7: The BM-SC begins ingesting the MPD and this content from the DVB-DASH server.

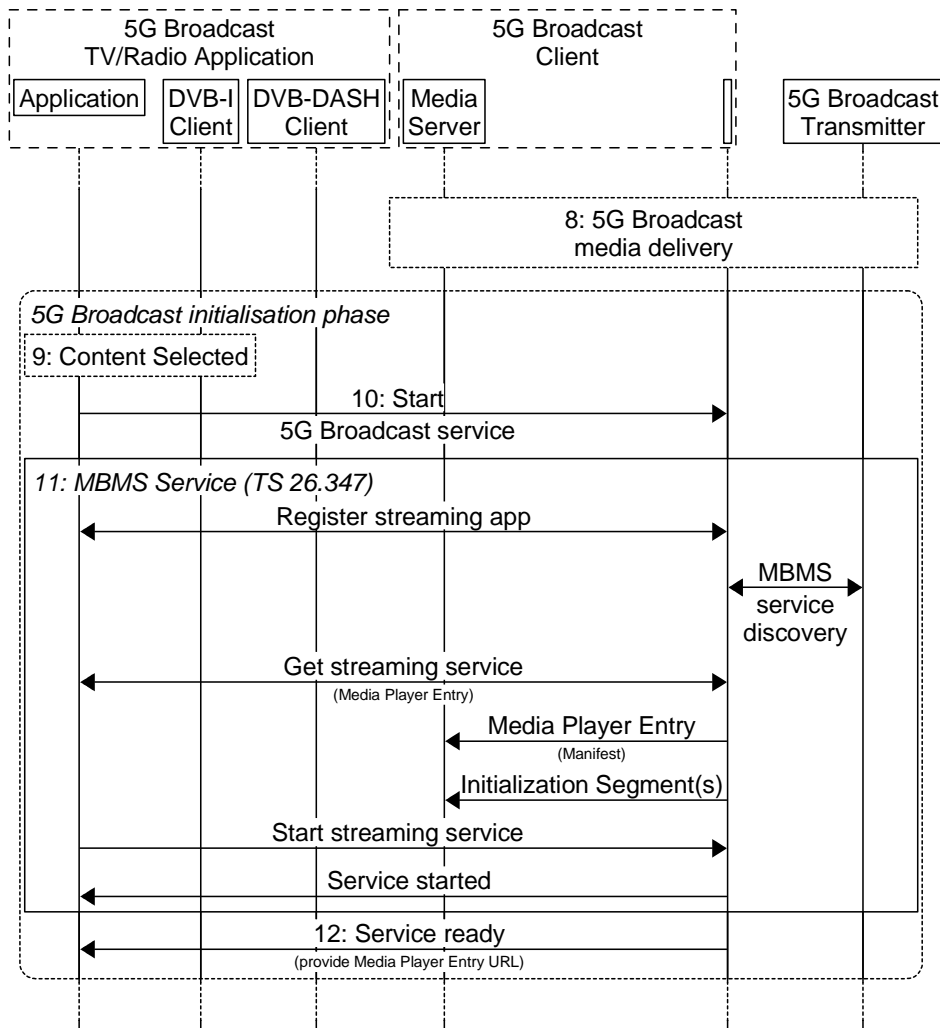

**Figure 6.4.4.2-2: Hybrid broadcast-unicast delivery - Service discovery and selection**

- Step 8: The BM SC starts one or more MBMS Delivery Sessions.
- Step 9: The media content is selected by the Application in collaboration with the DVB-I Client.
- Step 10: The Application initiates reception of the 5G Broadcast Service .
- Step 11: The Application initiates MBMS streaming services.
- Step 12: The 5G Broadcast Client informs the Application that the service is ready.

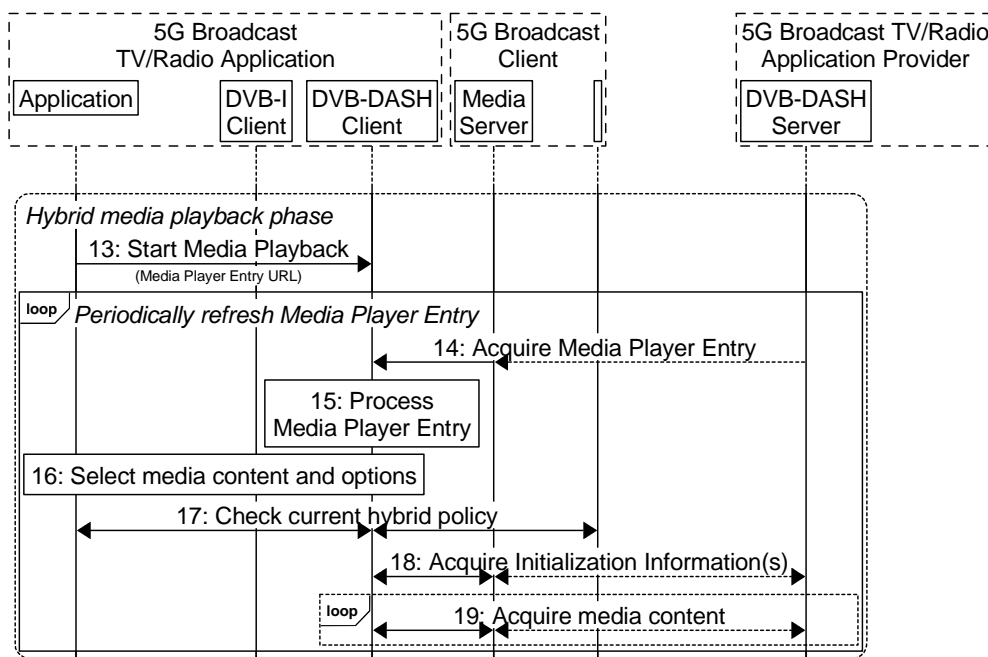

**Figure 6.4.4.2-3: Hybrid broadcast-unicast delivery - Service delivery**

- Step 13: The Application starts media playback.
- Step 14: The client Media Entry Point document (typically a media presentation manifest) is acquired by the DVB-DASH Client. It may be available from the local MBMS Client's Media Server or from the DVB-DASH Server, or even from both.
- Step 15: The DVB-DASH Client processes the client Media Entry Point document and identifies that content is available from different data networks (the local Media Server and the DVB-DASH Client).
- Step 16: Under the control of the Application, the DVB-DASH Client selects the content and different content options offered in the Media Entry Point document.
- Step 17: Under the control of the Application, the DVB-DASH Client continuously checks if MBMS User Service data is available based on the information in the MPD or the information provided through the SAND4M messages. This depends on the hybrid scenario. Different policies may be considered. For more details on scenarios, see:
- Service continuity in clause 6.4.4.3.2.
  - Timeshifted viewing in clause 6.4.4.3.3.
  - Content or component replacement in clause 6.4.4.3.4.
- Step 18: The DVB-DASH Client acquires initialization information either from the local Media Server or from the DVB-DASH server, repeating this step for each required initialization segment.
- Step 19: The DVB-DASH client acquires media segments according to the DVB-DASH client Entry, either from the local Media Server or from the DVB-DASH Server. The received media segments are fed into the appropriate media rendering pipeline.

Steps 14-19 are repeated according to the refresh information signalled in the Media Entry Point document.

### 6.4.4.3 Supporting hybrid unicast-broadcast service use cases for option 1

#### 6.4.4.3.1 Introduction

To support the different hybrid unicast-broadcast service use cases introduced in clause 6.4.1, the procedures and call flows documented for hybrid option 1 in clause 6.4.4.2 above may be modulated as follows.

#### 6.4.4.3.2 Service continuity

In this use case, the service is made available via both unicast and 5G Broadcast delivery networks, but only one Representation of each Adaptation Set is provided via 5G Broadcast. In addition, the MBMS User Service signals the availability of broadcast and unicast network resources. In this case, the following instantiations apply:

- In step 2, one Representation of each Adaptation Set is distributed via 5G Broadcast.
- As long as the DVB-DASH service is accessible over 5G Broadcast, the DVB-DASH Client is forced to select the media content in step 13 as well as steps 17-20 from the local Media Server based on the communication with the 5G Broadcast client; content is not accessed from the DVB-DASH Server in the network.
- If the service becomes unavailable via 5G Broadcast, the DASH Player switches to accessing the media content in step 13 as well as steps 17-20 from the DVB-DASH Server via unicast based on instructions in the MPD communication with the MBMS client.
- Once the streaming service becomes available again via 5G Broadcast, the Media Player switches back to accessing the media content in step 13 as well as steps 17-20 from the local Media Server based on instructions in the MPD communication with the MBMS client.

#### 6.4.4.3.3 Time-shifted viewing

In this use case, the service is made available via both unicast and 5G Broadcast networks, but only one Representation of each Adaptation Set is provided via 5G Broadcast. The content is retained by the DVB-DASH server for a period of time to support time-shifted access. In this case, the following instantiations apply:

- In step 2, one Representation of each Adaptation Set is distributed via 5G Broadcast.
- If the streaming service is accessible via 5G Broadcast and the user is consuming content at the live edge, the Media Player selects the media content in the step 13 as well as steps 17-20 from the local Media Server; content is not accessed from the DASH server.
- If the user switches to time-shift viewing mode or streaming service becomes unavailable via 5G Broadcast, the DASH client switches to accessing the media content in the step 13 as well as steps 17-20 from the DVB-DASH server.
- Once the streaming service becomes available again via 5G Broadcast and the user returns to the live edge, the Media Player switches back to accessing the media content in the step 13 as well as steps 17-20 from the local Media Server.

This case can only be solved by providing the time-shifted unicast content in the MPD, such that the DVB-DASH client can make these decisions. This means that in case the MPD is modified by the 5G Broadcast client, it does not remove unicast resources, but provides priorities to select broadcast resources as long as they are available. In case of SAND4M messages, such priorities may be signalled to the DASH client.

#### 6.4.4.3.4 Content or component replacement

In this use case, the service is made available via both unicast and 5G Broadcast delivery networks, but only one Representation of selected Adaptation Sets is provided via 5G Broadcast. Some Adaptation Sets are only available via unicast, for example a specific language or a specific, potentially less popular version of the video. In another case, two or more content alternatives may exist for a period of time, but only one alternative is provided over 5G Broadcast (for example, broadcast-delivered main content interspersed with unicast-delivered targeted advertisements). Note that such functionalities may be used for targeted ad insertion as introduced in clause 4.2.6. However, the detailed set of procedures and messages to support a TA system via hybrid 5G unicast and broadcast is for further study.

In this case, the following instantiations apply:

- In step 2, the hybrid Media Player Entry document (i.e. DVB-DASH MPD) describes the different content alternatives available to the DVB-DASH Client.
- If the streaming service is accessible over 5G Broadcast and the user watches content available on broadcast, the DVB-DASH Client selects the media content in step 13 as well as steps 17-20 from the MBMS Client's local Media Server; content is not accessed from the DVB-DASH Server in the network.

- If the user or presentation timeline switches to content or content components available only via unicast, the DVB-DASH Client switches to accessing the media content in the step 13 as well as steps 17-20 from the DVB-DASH Server. If only one component is replaced with the main broadcast, for example the audio, the DVB-DASH Client accesses media content from the MBMS Client's local Media Server (the video content received via 5G Broadcast) and from the DVB-DASH Server (the specific audio content) at the same time.

Similar, this case can only be solved by providing the unicast-only content in the MPD, such that the DVB-DASH client can make these decisions. This means that in case the MPD is modified by the 5G Broadcast client, it does not remove unicast resources that are uniquely available on unicast.

#### 6.4.4.4 Potential extensions to existing specifications

In the case of hybrid options 1 and 2, and for all considered use cases, a single unified MPD is created that contains content received over broadcast and content accessible over unicast. In order to support different delivery networks and access, the DVB DASH Client is expected to operate on different Base URLs.

In order to address policy questions, either the 5G Broadcast Client (in hybrid option 1) or the DVB-DASH Client, possibly in collaboration with the Application (hybrid option 2) needs to define which network resources are selected at what time. The DVB-DASH Client needs to be able to receive content from at least two different networks and needs to be actively steered towards selecting one or the other network, perhaps using additional signalling in the MPD. Such an extension may be considered in DVB-DASH.

For hybrid option 3, two separate MPDs are provided, each one describing an instance of the same DVB-I service. New signalling is required in the DVB-I Service List to indicate that the content distributed on these two service instances is both identical and time-aligned, and that the content can therefore be combined into a single hybrid presentation to the user. In addition, the policies for this hybrid service (e.g. which service instance has priority) also need to be included in the DVB-I Service List using existing signalling specified in ETSI TS 103 770 [i.21]. Furthermore, it is likely that the operation of the DVB-DASH Client would need to be modified in order to support switching between the two presentations described by the two MPDs.

It is also identified that for full exploitation of targeted ad insertion in the context of hybrid services, the DVB targeted ad insertion solution is preferably augmented with an architecture and a set of procedures, such that the mapping to 5G operation is simplified. Such a decomposition may identify if any gaps to support DVB-TA via 5G exist. The details are for further study.

---

## History

<b>Document history</b>		
V1.1.1	July 2023	Publication