

ETSI EN 303 213-5-1 V2.1.1 (2023-10)



**Advanced Surface Movement Guidance and
Control System (A-SMGCS);
Part 5: Harmonised Standard for access to
radio spectrum for Multilateration (MLAT) equipment;
Sub-part 1: Receivers and Interrogators**

ReferenceREN/ERM-TGAERO-100

Keywordsaeronautical, harmonised standard,
interoperability, radio

ETSI650 Route des Lucioles
F-06921 Sophia Antipolis Cedex - FRANCE

Tel.: +33 4 92 94 42 00 Fax: +33 4 93 65 47 16

Siret N° 348 623 562 00017 - APE 7112B
Association à but non lucratif enregistrée à la
Sous-Préfecture de Grasse (06) N° w061004871

Important notice

The present document can be downloaded from:
<https://www.etsi.org/standards-search>

The present document may be made available in electronic versions and/or in print. The content of any electronic and/or print versions of the present document shall not be modified without the prior written authorization of ETSI. In case of any existing or perceived difference in contents between such versions and/or in print, the prevailing version of an ETSI deliverable is the one made publicly available in PDF format at www.etsi.org/deliver.

Users of the present document should be aware that the document may be subject to revision or change of status. Information on the current status of this and other ETSI documents is available at <https://portal.etsi.org/TB/ETSIDeliverableStatus.aspx>

If you find errors in the present document, please send your comment to one of the following services:
<https://portal.etsi.org/People/CommitteeSupportStaff.aspx>

If you find a security vulnerability in the present document, please report it through our Coordinated Vulnerability Disclosure Program:
<https://www.etsi.org/standards/coordinated-vulnerability-disclosure>

Notice of disclaimer & limitation of liability

The information provided in the present deliverable is directed solely to professionals who have the appropriate degree of experience to understand and interpret its content in accordance with generally accepted engineering or other professional standard and applicable regulations.

No recommendation as to products and services or vendors is made or should be implied. In no event shall ETSI be held liable for loss of profits or any other incidental or consequential damages.

Any software contained in this deliverable is provided "AS IS" with no warranties, express or implied, including but not limited to, the warranties of merchantability, fitness for a particular purpose and non-infringement of intellectual property rights and ETSI shall not be held liable in any event for any damages whatsoever (including, without limitation, damages for loss of profits, business interruption, loss of information, or any other pecuniary loss) arising out of or related to the use of or inability to use the software.

Copyright Notification

No part may be reproduced or utilized in any form or by any means, electronic or mechanical, including photocopying and microfilm except as authorized by written permission of ETSI.

The content of the PDF version shall not be modified without the written authorization of ETSI. The copyright and the foregoing restriction extend to reproduction in all media.

© ETSI 2023.
All rights reserved.

Contents

Intellectual Property Rights	6
Foreword.....	6
Modal verbs terminology.....	7
Introduction	7
1 Scope	8
2 References	8
2.1 Normative references	8
2.2 Informative references.....	8
3 Definition of terms, symbols and abbreviations.....	9
3.1 Terms.....	9
3.2 Symbols.....	10
3.3 Abbreviations	10
4 Technical requirements specifications	11
4.1 Environmental profile.....	11
4.2 Conformance Requirements	11
4.2.1 Applicability	11
4.2.1.1 Equipment with and without integral antenna.....	11
4.2.1.2 Equipment with multiple functions	11
4.2.2 Transmitter requirements.....	11
4.2.2.1 Operating frequency and frequency error	11
4.2.2.1.1 Definition.....	11
4.2.2.1.2 Limits	11
4.2.2.1.3 Conformance	11
4.2.2.2 Spectrum mask.....	11
4.2.2.2.1 Definition.....	11
4.2.2.2.2 Limits	12
4.2.2.2.3 Conformance	12
4.2.2.3 Residual Power Output	12
4.2.2.3.1 Definition.....	12
4.2.2.3.2 Limits	12
4.2.2.3.3 Conformance	13
4.2.2.4 Spurious emissions of transmitter in active mode.....	13
4.2.2.4.1 Definition.....	13
4.2.2.4.2 Limits	13
4.2.2.4.3 Conformance	13
4.2.2.5 Transmitter Intermodulation attenuation.....	13
4.2.2.5.1 Definition.....	13
4.2.2.5.2 Limits	13
4.2.2.5.3 Conformance	14
4.2.2.6 Transmitter time domain characteristics	14
4.2.2.6.1 Definition.....	14
4.2.2.6.2 Limits	14
4.2.2.6.3 Conformance	14
4.2.3 Receiver requirements	15
4.2.3.1 Sensitivity variation over the operating frequency range.....	15
4.2.3.1.1 Definition.....	15
4.2.3.1.2 Limits	15
4.2.3.1.3 Conformance	15
4.2.3.2 RF selectivity and spurious response rejection	15
4.2.3.2.1 Definition.....	15
4.2.3.2.2 Limits	15
4.2.3.2.3 Conformance	15
4.2.3.3 Inter-modulation response rejection.....	16
4.2.3.3.1 Definition.....	16

4.2.3.3.2	Limits	16
4.2.3.3.3	Conformance	16
4.2.3.4	Co-channel rejection	16
4.2.3.4.1	Definition.....	16
4.2.3.4.2	Limits	16
4.2.3.4.3	Conformance	16
4.2.3.5	Blocking.....	16
4.2.3.5.1	Definition.....	16
4.2.3.5.2	Limits	16
4.2.3.5.3	Conformance	16
4.2.3.6	Sensitivity	17
4.2.3.6.1	Definition.....	17
4.2.3.6.2	Limits	17
4.2.3.6.3	Conformance	17
4.2.3.7	Receiver spurious emissions	17
4.2.3.7.1	Definition.....	17
4.2.3.7.2	Limits	17
4.2.3.7.3	Conformance	17
4.2.3.8	Receiver dynamic range.....	17
4.2.3.8.1	Definition.....	17
4.2.3.8.2	Limits	17
4.2.3.8.3	Conformance	18
5	Testing for compliance with technical requirements.....	18
5.1	Environmental conditions for testing	18
5.1.1	General requirements.....	18
5.1.2	Test Conditions	18
5.1.2.1	Thermal Balance	18
5.1.2.2	Normal Test Conditions	18
5.1.2.2.1	Temperature and humidity.....	18
5.1.2.2.2	Power supply	18
5.1.2.3	Extreme Test Conditions	19
5.1.2.3.1	Temperature and humidity.....	19
5.1.2.3.2	Power supply	19
5.2	Test and General Conditions	19
5.2.1	Transmitter test signals	19
5.2.1.1	General Considerations	19
5.2.1.2	Test signal 1	19
5.2.1.3	Test signal 2	20
5.2.2	Simulated received signals.....	20
5.2.2.1	General Considerations	20
5.2.2.2	Test signal 3	20
5.2.2.3	Test signal 4	21
5.2.2.4	Test signal 5	21
5.3	Transmitter tests	21
5.3.1	Operating frequency and frequency error	21
5.3.1.1	Description	21
5.3.1.2	Test conditions	21
5.3.1.3	Method of measurement.....	21
5.3.1.4	Measurement procedure	22
5.3.2	Spectrum mask.....	22
5.3.2.1	Description.....	22
5.3.2.2	Test conditions	22
5.3.2.3	Method of measurement.....	22
5.3.2.4	Measurement procedure	23
5.3.3	Residual Power Output	23
5.3.3.1	Description	23
5.3.3.2	Test conditions	23
5.3.3.3	Method of measurement.....	23
5.3.3.4	Measurement procedure	23
5.3.4	Spurious emissions of transmitter in active mode.....	24
5.3.4.1	Description	24

5.3.4.2	Test conditions	24
5.3.4.3	Method of measurement.....	24
5.3.4.4	Measurement Procedure.....	24
5.3.4.4.1	Part 1: Measurement of PEP and determination of spurious emission limit.....	24
5.3.4.4.2	Part 2: Spurious emission measurement procedure	25
5.3.5	Transmitter intermodulation attenuation.....	25
5.3.5.1	Description	25
5.3.5.2	Test Conditions	25
5.3.5.3	Method of Measurement	26
5.3.5.4	Measurement Procedure.....	26
5.3.6	Transmitter time domain characteristics	27
5.3.6.1	Description	27
5.3.6.2	Test Conditions	27
5.3.6.3	Method of measurement.....	27
5.3.6.4	Measurement procedure	27
5.4	Receiver Tests	28
5.4.1	Sensitivity and Sensitivity variation over the operating frequency range	28
5.4.1.1	Description	28
5.4.1.2	Test conditions	28
5.4.1.3	Method of measurement.....	28
5.4.1.4	Measurement procedure	28
5.4.2	RF selectivity and spurious response rejection	29
5.4.2.1	Description	29
5.4.2.2	Test conditions	29
5.4.2.3	Method of measurement.....	29
5.4.2.4	Measurement procedure	29
5.4.3	Inter-modulation response rejection	30
5.4.3.1	Description	30
5.4.3.2	Test conditions	30
5.4.3.3	Method of measurement.....	30
5.4.3.4	Measurement procedure	31
5.4.4	Co-channel rejection	31
5.4.4.1	Description	31
5.4.4.2	Test conditions	31
5.4.4.3	Method of measurement.....	31
5.4.4.4	Measurement procedure	32
5.4.5	Blocking.....	32
5.4.5.1	Description	32
5.4.5.2	Test conditions	32
5.4.5.3	Method of measurement.....	32
5.4.5.4	Measurement procedure	33
5.4.6	Receiver spurious emissions	33
5.4.6.1	Description	33
5.4.6.2	Test conditions	33
5.4.6.3	Method of measurement.....	33
5.4.6.4	Measurement Procedure.....	34
5.4.7	Receiver Dynamic Range	34
5.4.7.1	Description	34
5.4.7.2	Test Conditions	34
5.4.7.3	Method of measurement.....	34
5.4.7.4	Measurement procedure	35
Annex A (informative):	Relationship between the present document and the essential requirements of Directive 2014/53/EU	36
Annex B (informative):	Maximum measurement uncertainty	38
Annex C (informative):	Checklist	39
Annex D (informative):	Bibliography	40
Annex E (informative):	Change history	41
History		42

Intellectual Property Rights

Essential patents

IPRs essential or potentially essential to normative deliverables may have been declared to ETSI. The declarations pertaining to these essential IPRs, if any, are publicly available for **ETSI members and non-members**, and can be found in ETSI SR 000 314: "*Intellectual Property Rights (IPRs); Essential, or potentially Essential, IPRs notified to ETSI in respect of ETSI standards*", which is available from the ETSI Secretariat. Latest updates are available on the ETSI Web server (<https://ipr.etsi.org/>).

Pursuant to the ETSI Directives including the ETSI IPR Policy, no investigation regarding the essentiality of IPRs, including IPR searches, has been carried out by ETSI. No guarantee can be given as to the existence of other IPRs not referenced in ETSI SR 000 314 (or the updates on the ETSI Web server) which are, or may be, or may become, essential to the present document.

Trademarks

The present document may include trademarks and/or tradenames which are asserted and/or registered by their owners. ETSI claims no ownership of these except for any which are indicated as being the property of ETSI, and conveys no right to use or reproduce any trademark and/or tradename. Mention of those trademarks in the present document does not constitute an endorsement by ETSI of products, services or organizations associated with those trademarks.

DECT™, **PLUGTESTS™**, **UMTS™** and the ETSI logo are trademarks of ETSI registered for the benefit of its Members. **3GPP™** and **LTE™** are trademarks of ETSI registered for the benefit of its Members and of the 3GPP Organizational Partners. **oneM2M™** logo is a trademark of ETSI registered for the benefit of its Members and of the oneM2M Partners. **GSM®** and the GSM logo are trademarks registered and owned by the GSM Association.

Foreword

This Harmonised European Standard (EN) has been produced by ETSI Technical Committee Electromagnetic compatibility and Radio spectrum Matters (ERM).

The present document has been prepared under the Commission's standardisation request C(2015) 5376 final [i.3] to provide one voluntary means of conforming to the essential requirements of Directive 2014/53/EU on the harmonisation of the laws of the Member States relating to the making available on the market of radio equipment and repealing Directive 1999/5/EC [i.1].

Once the present document is cited in the Official Journal of the European Union under that Directive, compliance with the normative clauses of the present document given in Table A.1 confers, within the limits of the scope of the present document, a presumption of conformity with the corresponding essential requirements of that Directive, and associated EFTA regulations.

The present document is part 5, sub-part 1, of a multi-part deliverable covering Advanced Surface Movement Guidance and Control System (A-SMGCS), as identified below.

- Part 1: "Community Specification for A-SMGCS surveillance service including external interfaces";
- Part 2: "Community Specification for A-SMGCS airport safety support service";
- Part 3: "Community Specification for a deployed cooperative sensor including its interfaces";
- Part 4: "Community Specification for a deployed non-cooperative sensor including its interfaces";

Part 5: "Harmonised Standard for access to radio spectrum for Multilateration (MLAT) equipment":

Sub-part 1: "Receivers and Interrogators";

Sub-part 2: "Reference and vehicle transmitters";

Part 6: "Harmonised Standard for access to radio spectrum for deployed surface movement radar sensors";

Part 7: "Community Specification for A-SMGCS routing service";

Part 8: "Community Specification for A-SMGCS guidance service".

National transposition dates	
Date of adoption of this EN:	3 October 2023
Date of latest announcement of this EN (doa):	31 January 2024
Date of latest publication of new National Standard or endorsement of this EN (dop/e):	31 July 2024
Date of withdrawal of any conflicting National Standard (dow):	31 July 2025

Modal verbs terminology

In the present document "**shall**", "**shall not**", "**should**", "**should not**", "**may**", "**need not**", "**will**", "**will not**", "**can**" and "**cannot**" are to be interpreted as described in clause 3.2 of the [ETSI Drafting Rules](#) (Verbal forms for the expression of provisions).

"**must**" and "**must not**" are **NOT** allowed in ETSI deliverables except when used in direct citation.

Introduction

A-SMGCS are systems providing routing, guidance, surveillance and control to aircraft and affected vehicles in order to maintain movement rate under all local weather conditions within the Aerodrome Visibility Operational Level (AVOL) whilst maintaining the required level of safety.

1 Scope

The present document specifies technical characteristics and methods of measurements for the following equipment:

- 1) Interrogators transmitting in the 1 030 MHz band, used in Mode S multilateration equipment in an Advanced Surface Movement Guidance and Control System (A-SMGCS).
- 2) Receivers, receiving in the 1 090 MHz band, used in Mode S multilateration equipment in an Advanced Surface Movement Guidance and Control System (A-SMGCS).

Antennas for this equipment are passive without an additional amplifier.

NOTE: The relationship between the present document and essential requirements of article 3.2 of Directive 2014/53/EU [i.1] is given in Annex A.

2 References

2.1 Normative references

References are either specific (identified by date of publication and/or edition number or version number) or non-specific. For specific references, only the cited version applies. For non-specific references, the latest version of the referenced document (including any amendments) applies.

Referenced documents which are not found to be publicly available in the expected location might be found at <https://docbox.etsi.org/Reference/>.

NOTE: While any hyperlinks included in this clause were valid at the time of publication, ETSI cannot guarantee their long term validity.

The following referenced documents are necessary for the application of the present document.

- [1] [ICAO Annex 10, Volume IV](#): "Surveillance Radar and Collision Avoidance Systems", 5th edition, July 2014, including amendments up to amendment 91 dated 18-07-2022.
- [2] Void.
- [3] [ETSI EN 300 019-1-3 \(V2.4.1\) \(04-2014\)](#): "Environmental Engineering (EE); Environmental conditions and environmental tests for telecommunications equipment; Part 1-3: Classification of environmental conditions; Stationary use at weatherprotected locations".
- [4] [ETSI EN 300 019-1-4 \(V2.2.1\) \(04-2014\)](#): "Environmental Engineering (EE); Environmental conditions and environmental tests for telecommunications equipment; Part 1-4: Classification of environmental conditions; Stationary use at non-weatherprotected locations".

2.2 Informative references

References are either specific (identified by date of publication and/or edition number or version number) or non-specific. For specific references, only the cited version applies. For non-specific references, the latest version of the referenced document (including any amendments) applies.

NOTE: While any hyperlinks included in this clause were valid at the time of publication, ETSI cannot guarantee their long term validity.

The following referenced documents are not necessary for the application of the present document but they assist the user with regard to a particular subject area.

- [i.1] [Directive 2014/53/EU](#) of the European Parliament and of the Council of 16 April 2014 on the harmonisation of the laws of the Member States relating to the making available on the market of radio equipment and repealing Directive 1999/5/EC.

- [i.2] ITU Radio Regulations (2020).
- [i.3] [Commission Implementing Decision C\(2015\) 5376 final of 4.8.2015](#) on a standardisation request to the European Committee for Electrotechnical Standardisation and to the European Telecommunications Standards Institute as regards radio equipment in support of Directive 2014/53/EU of the European Parliament and of the Council.
- [i.4] [ECC/Recommendation \(02\)05 \(2012\)](#): "Unwanted emissions".
- [i.5] ETSI EG 203 336 (V1.2.1): "Guide for the selection of technical parameters for the production of Harmonised Standards covering article 3.1(b) and article 3.2 of Directive 2014/53/EU".
- [i.6] [ERC/Recommendation 74-01 \(2019\)](#): "Unwanted emissions in the spurious domain".
- [i.7] EUROCAE ED-117A (September 2016): "MOPS for Mode S Multilateration Systems for Use in Advanced Surface Movement Guidance and Control Systems (A-SMGCS)".

3 Definition of terms, symbols and abbreviations

3.1 Terms

For the purposes of the present document, the following terms apply:

conducted measurements: measurements which are made using a wired connection to the EUT

duty cycle: ratio expressed as a percentage, of the cumulative duration of transmissions within an observation interval and the interval itself, as measured in an observation bandwidth

equipment under test: system of constituents provided by the manufacturer for qualification under the present document

ground based multilateration equipment or ground station: aeronautical station equipment intended for use in an A-SMGCS multilateration component

interrogator: aeronautical station equipment including at least one transmitter designed to produce aeronautical mobile service signals at 1 030 MHz

Mode S: particular type of uplink or downlink message defined in ICAO Annex 10, Volume IV [1]

multilateration: surveillance technique which provides position derived from the Secondary Surveillance Radar (SSR) transponder signals (replies or squitters) primarily using Time Difference Of Arrival (TDOA) techniques

NOTE: Additional information, including identification, can be extracted from the received signals.

Operating Channel (OC): frequency range in which the transmission from the EUT occurs, or in which the EUT is intended to receive transmissions

operating frequency: centre of the OC

out of band emissions: power transmitted at frequencies outside the OC but within the specified spectral mask

probability of detection: rate of correctly received and decoded squitter messages

receiver: EUT which includes the capability to convert RF signals into binary content

resolution bandwidth: bandwidth that is used for spectral measurements

transmission: radio emission consisting of one uplink or downlink Mode S message

transmitter: EUT which includes the capability to convert binary content into RF signals

transponder: aeronautical station equipment including at least one transmitter designed to produce aeronautical mobile radionavigation service signals at 1 090 MHz and zero or more receivers designed to receive aeronautical mobile radionavigation service signals at 1 030 MHz

unwanted signal: any signal other than the wanted signal or as described in a specific test case

wanted signal: in-band signal modulated according to the Mode specification

NOTE: Some manufacturers may also accept Mode 3A/C and other modulations which is beyond the scope of the present document.

3.2 Symbols

For the purposes of the present document, the following symbols apply:

dB	decibel
dBc	dB relative to carrier
dBm	power in dB relative to 1 milliwatt
dBpp	dB below PEP
f	measurement frequency
μs	Microsecond
Ω	Ohm

3.3 Abbreviations

For the purposes of the present document, the following abbreviations apply:

AC	Alternating Current
ADS-B	Automatic Dependant Surveillance Broadcast
A-SMGCS	Advanced Surface Movement Guidance and Control System
AVOL	Aerodrome Visibility Operational Level
CRC	Cyclic Redundancy Check
CW	Continuous Wave
DC	Direct Current
DF	Downlink Format
DME	Distance Measuring Equipment
EUT	Equipment Under Test
ICAO	International Civil Aviation Organization
MLAT	Multilateration
MOPS	Minimum Operational Performance Specification
NA	Not Applicable
NA	Not Applicable
OC	Operating Channel
OOB	Out Of Band
PD	Probability of Detection
PEP	Peak Envelope Power
RBW	Reference BandWidth
RF	Radio Frequency
RX	Receive
SSR	Secondary Surveillance Radar
TX	Transmit
VBW	Video BandWidth

4 Technical requirements specifications

4.1 Environmental profile

The technical requirements of the present document apply under the environmental profile for operation of the equipment, which shall be in accordance with its intended use but, as a minimum, shall be that specified in the test conditions contained in the present document. The equipment shall comply with all the technical requirements of the present document at all times when operating within the boundary limits of the operational environmental profile defined by its intended use.

4.2 Conformance Requirements

4.2.1 Applicability

4.2.1.1 Equipment with and without integral antenna

For the purposes of conducted measurements on an EUT, a 50 Ω connection point shall be provided for test purposes.

For EUT with integral antenna, the connection point shall correspond to the input of the integral antenna.

4.2.1.2 Equipment with multiple functions

Any ground station which includes the interrogator function shall comply with the requirements in clause 4.2.2.

Any ground station which includes the receiver function shall comply with the requirements in clause 4.2.3.

4.2.2 Transmitter requirements

4.2.2.1 Operating frequency and frequency error

4.2.2.1.1 Definition

The operating frequency is the nominal value of the carrier frequency.

The frequency error is the difference between the actual carrier frequency and its nominal value of 1 030 MHz.

4.2.2.1.2 Limits

The nominal value of carrier frequency of the interrogation and control transmissions shall be 1 030 MHz.

The absolute value of the frequency error shall not exceed 0,01 MHz.

NOTE: This limit is specified in ICAO Annex 10, Volume IV [1], clause 3.1.2.1.1 and is stricter than the requirement defined in the ITU Radio Regulations [i.2], Appendix 2.

4.2.2.1.3 Conformance

The conformance tests for this requirement are defined in clause 5.3.1.

4.2.2.2 Spectrum mask

4.2.2.2.1 Definition

A spectrum mask is a set of limit lines applied to a plot of a transmitter spectrum.

The Out of Band domain extends to ± 125 MHz from the actual carrier frequency of 1 030 MHz. The frequencies outside the Out of Band domain are defined as the spurious domain.

4.2.2.2.2 Limits

The measured spectrum shall be below the limit lines shown in Figure 1.

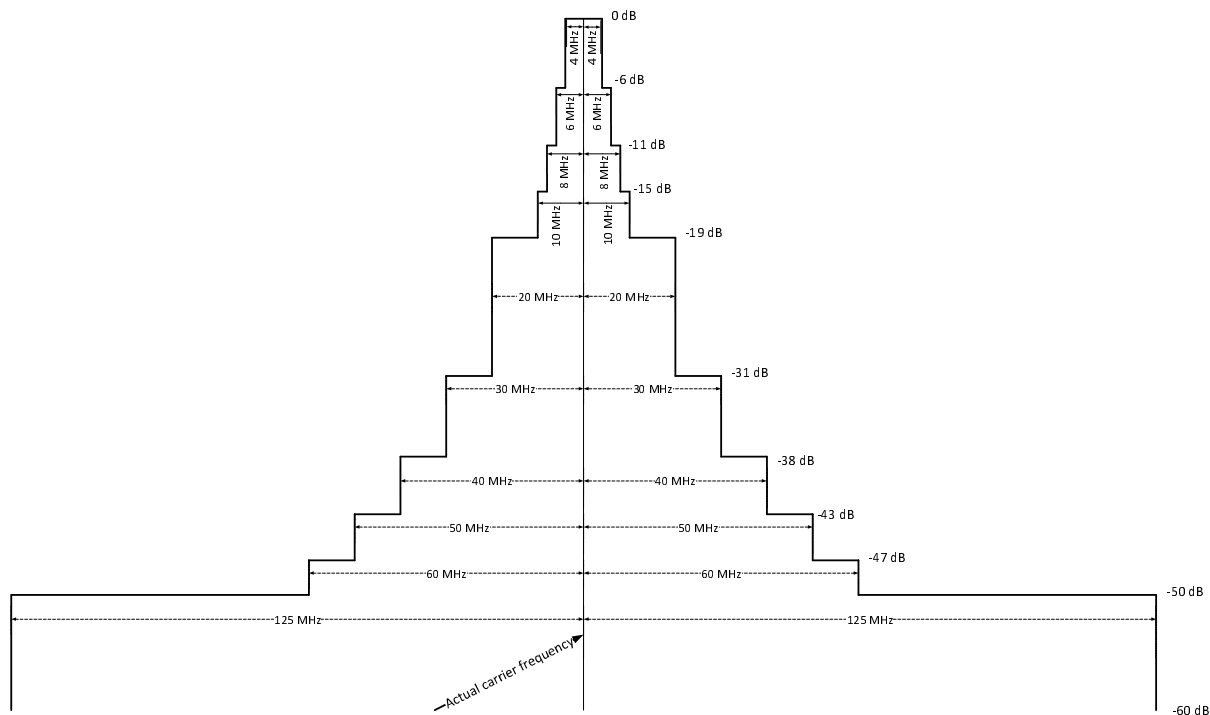

Figure 1: Spectrum mask for an interrogator transmitter

NOTE: The spectrum mask specified in ICAO Annex 10, Volume 4 [1], Figure 3-2 has been modified in order to be consistent with the ITU Radio Regulations [i.2], Appendix 3. The ICAO mask was extrapolated from the last three steps to determine when the mask would intercept the -60 dB point. A value of approximately 125 MHz was reached. 125 MHz is also the point reached when extrapolating the mask from the -40 dB (i.e. 40 MHz) by -40 dB per decade, which is the design objective for the 60 dBpp systems reflected in ECC/Recommendation (02)05 [i.4], Table 3 until the spurious limit is reached. This is also reflected in ECC/Recommendation (02)05 [i.4], Figure A2.1, item a), the Emission Mask for radars.

4.2.2.2.3 Conformance

The conformance tests for this requirement are defined in clause 5.3.2.

4.2.2.3 Residual Power Output

4.2.2.3.1 Definition

The residual power output is the power output when not in the active state.

4.2.2.3.2 Limits

The residual power output shall not exceed the limits specified in Table 1.

Table 1: Limits and measurement bands for the residual power output

Frequency Range	Limits
9 kHz \leq f \leq 1 000 MHz	-57 dBm
1 000 MHz < f \leq 6 000 MHz (see note 1)	-47 dBm
NOTE 1: The upper band measurement limit corresponds to the 5 th harmonic (5 150 MHz) as defined in ERC/Recommendation 74-01 [i.6], Table 1 plus a margin.	
NOTE 2: These limits are specified in ERC/Recommendation 74-01 [i.6], Table 2.	

4.2.2.3.3 Conformance

The conformance tests for this requirement are defined in clause 5.3.3.

4.2.2.4 Spurious emissions of transmitter in active mode

4.2.2.4.1 Definition

Spurious emissions are unwanted emissions in the spurious domain. For active transmitters, the spurious domain is all frequencies apart from the operating channel and the Out-of-Band domain.

4.2.2.4.2 Limits

The power of any unwanted emission in the spurious domain shall not exceed $43 + 10 \cdot \log(\text{PEP})$ or 60 dB below PEP (whichever is less stringent) in the frequency range defined in Table 2.

NOTE 1: For $\text{PEP} \leq 50$ W, the limit is equal to -13 dBm.

Table 2: Measurement bands for the emissions in the spurious domain

Lower band	Upper band
9 kHz \leq f < 905 MHz (see note 1, note 3)	1 155 MHz < f \leq 6 000 MHz (see note 2, note 4)
NOTE 1: The lower band measurement limits are defined in ERC/Recommendation 74-01 [i.6].	
NOTE 2: The upper band measurement limit corresponds to the 5 th harmonic (5 150 MHz) as defined in ERC/Recommendation 74-01 [i.6], Table 1 plus a margin.	
NOTE 3: The lower edge of the Out-of-Band Domain equals $f_c - 125$ MHz = 905 MHz.	
NOTE 4: The upper edge of the Out-of-Band Domain equals $f_c + 125$ MHz = 1 155 MHz.	

NOTE 2: These limits are specified in the ITU Radio Regulations [i.2], Appendix 3.

4.2.2.4.3 Conformance

The conformance tests for this requirement are defined in clause 5.3.4.

4.2.2.5 Transmitter Intermodulation attenuation

4.2.2.5.1 Definition

The transmitter intermodulation attenuation is a measure of the capability of a transmitter to inhibit the generation of signals in its non-linear elements caused by the presence of the transmitter power and an interfering signal entering the transmitter via its antenna. It is expressed by the intermodulation attenuation ratio specified as the ratio, in dB, of the PEP level to the power level of the third order intermodulation product.

4.2.2.5.2 Limits

The intermodulation attenuation ratio shall be at least 50 dB in the presence of an external unmodulated CW signal at a power level of +20 dBm or PEP -30 dB (whichever is lower) within a frequency range from 960 MHz to 1 215 MHz.

4.2.2.5.3 Conformance

The conformance tests for this requirement are defined in clause 5.3.5.

4.2.2.6 Transmitter time domain characteristics

4.2.2.6.1 Definition

The transmitter function is able to transmit different signal types, each one consisting of a series of modulated pulses.

Each pulse of the sequence has specific characteristics in terms of shape and timing in the sequence.

4.2.2.6.2 Limits

The transmitter shall fulfil the requirements as indicated in Table 3 and Table 4 (see also Figure 2).

Table 3: 1 030 MHz Mode S pulse shape

Pulse	Pulse length Duration (μs)		Rise Time (μs)		Decay Time (μs)	
	Min	Max	Min	Max	Min	Max
P1, P2	0,71	0,89	0,05	0,1	0,05	0,2
P6	16,05	16,45	0,05	0,1	0,05	0,2
Phase reversal		0,08		-		-

NOTE: This table is derived from ICAO Annex 10, Volume IV [1], section 3.1.2.11.7.

Table 4: 1 030 MHz Mode S pulse spacing

Pulses	Pulse spacing (μs)	
	Min	Max
P2 to P1 delay	1,96	2,04
P6 to sync phase reversal delay	1,21	1,29

NOTE: This table is derived from ICAO Annex 10, Volume IV [1], section 3.1.2.1.5.2 and section 3.1.2.1.4.2.1.

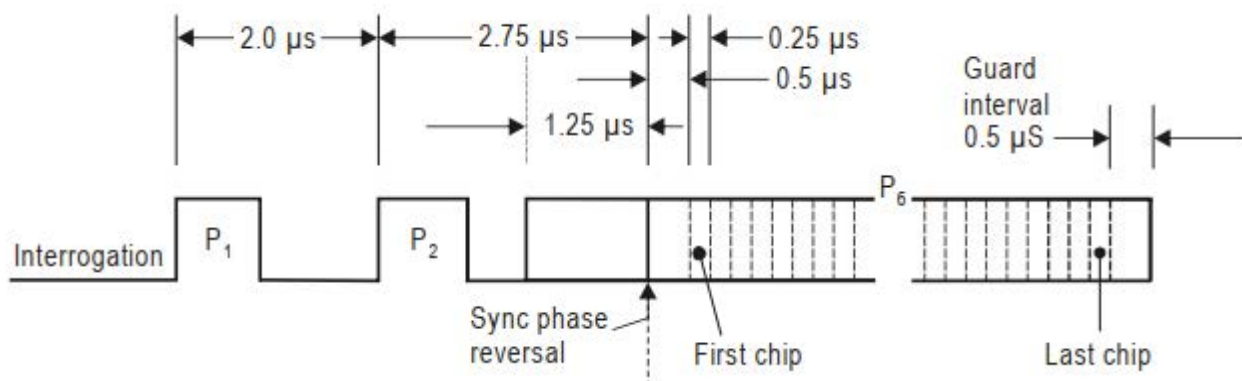

Figure 2: Pulse sequence of a 1 030 MHz Mode S Interrogation

4.2.2.6.3 Conformance

The conformance tests are specified in clause 5.3.6.

4.2.3 Receiver requirements

4.2.3.1 Sensitivity variation over the operating frequency range

4.2.3.1.1 Definition

The receiver sensitivity has the ability to receive a wanted signal at low input signal levels while providing a pre-determined level of performance. The operating frequency range is the frequency range around the nominal operating frequency over which reception of signals can be achieved.

4.2.3.1.2 Limits

The sensitivity shall not degrade by more than 3 dB as the incoming signal is offset by 1 MHz.

4.2.3.1.3 Conformance

The conformance tests for this requirement are defined in clause 5.4.1.

4.2.3.2 RF selectivity and spurious response rejection

4.2.3.2.1 Definition

RF selectivity and spurious response rejection are the ability of the EUT to avoid erroneous reception of signals from outside the desired frequency band.

Limits are evaluated assuming the signal is constructed as a valid Mode S waveform except that the frequency is altered. Although a 1 090 MHz system has only a single frequency channel, DME systems may occupy adjacent frequency allocations within the aviation band. It is important that the receiver rejects signals which are out of band while retaining sufficient bandwidth for acceptable multilateration performance.

4.2.3.2.2 Limits

The EUT shall reject signals such that the signal level of a valid message shall be increased by at least the value given for the frequency offset in Table 5 before the signal is received with the same Probability of detection or less.

EXAMPLE: The EUT receives a valid signal at 1 090 MHz with 90 % P_d at a level of -85 dBm. With a frequency offset of 19 MHz, the same probability of detection may be achieved only if the injected signal has a level of at least -65 dBm (20 dB higher). This shows that the receiver has at least 20 dB of rejection at the 19 MHz frequency offset.

NOTE 1: The limits were derived from receiver Out-of-Band rejection characteristics that are used within the industry for receivers that are used for both ADS-B and multilateration.

NOTE 2: These limits use valid Mode S signals in order to be a more stringent requirement for the receiver rejection.

Table 5: Minimum rejection level for messages

Frequency Offset (MHz) with respect to the operating frequency	Minimum Rejection level (dB)
$-19 < f \leq -12,5$ and $+12,5 \leq f < +19$	3
$-29 < f \leq -19$ and $+19 \leq f < +29$	20
$-46 < f \leq -29$ and $+29 \leq f < +46$	40
$f \leq -46$ and $f \geq +46$	60

4.2.3.2.3 Conformance

The conformance tests for this requirement are defined in clause 5.4.2.

4.2.3.3 Inter-modulation response rejection

4.2.3.3.1 Definition

The intermodulation response rejection is a measure of the capability of the receiver to receive a wanted modulated signal without exceeding a given degradation due to the presence of two or more unwanted signals with a specific frequency relationship relative to the receiver frequency.

4.2.3.3.2 Limits

At any frequency combination from -78 MHz to -20 MHz and from +20 MHz to +78 MHz from the receiver frequency of 1 090 MHz, the unwanted signals shall not reduce the probability of detection by more than 5 percentage points if their signal level is 40 dB above the reference sensitivity.

4.2.3.3.3 Conformance

The conformance tests for this requirement shall be as defined in clause 5.4.3.

4.2.3.4 Co-channel rejection

4.2.3.4.1 Definition

Co-channel rejection is the receiver's ability to receive a wanted signal in the presence of an unwanted signal, with the signals being at the nominal receiver frequency.

4.2.3.4.2 Limits

An unwanted signal with a level of 12 dB below the level of the wanted signal shall not reduce the rate of correctly received and decoded wanted Mode S signals by more than 5 percentage points.

4.2.3.4.3 Conformance

The conformance tests for this requirement are defined in clause 5.4.4.

4.2.3.5 Blocking

4.2.3.5.1 Definition

Blocking is a measure of the capability of the receiver to receive a wanted signal without exceeding a given degradation due to the presence of a strong unwanted signal.

4.2.3.5.2 Limits

The rate of correctly received and decoded wanted Mode S signals shall be reduced by no more than 5 percentage points in the presence of unwanted signals specified in Table 6.

Table 6: Unwanted signal characteristics

Frequency range	Level
1 090 MHz - 78 MHz to 1 090 MHz - 15 MHz	20 dB above the level of the wanted signal
1 090 MHz + 15 MHz to 1 090 MHz + 78 MHz	20 dB above the level of the wanted signal
NOTE: The level of the wanted signal is defined in clause 5.4.5.4.	

4.2.3.5.3 Conformance

The conformance tests for this requirement are defined in clause 5.4.5.

4.2.3.6 Sensitivity

4.2.3.6.1 Definition

The receiver sensitivity is the ability to receive a wanted signal at low input signal levels while providing a pre-determined level of performance.

4.2.3.6.2 Limits

Receivers shall operate for signals with a carrier frequency of 1 090 MHz with a PD of not less than 90 % at a desired signal level of -72 dBm.

NOTE: This number reflects a sensitivity for surveillance systems in order to support the requirements for Probability of Target Reports in EUROCAE ED-117A [i.7].

4.2.3.6.3 Conformance

The conformance tests for this requirement are defined in clause 5.4.1.

4.2.3.7 Receiver spurious emissions

4.2.3.7.1 Definition

Spurious emissions are unwanted emissions in the spurious domain. For Receivers the spurious domain is all frequencies, as they are not supposed to transmit any signal.

4.2.3.7.2 Limits

The power of any unwanted emission in the spurious domain shall not exceed the limits specified in Table 7.

Table 7: Limits and measurement bands for the receiver spurious emissions

Frequency Range	Limits
$9 \text{ kHz} \leq f \leq 1\,000 \text{ MHz}$	-57 dBm
$1\,000 \text{ MHz} < f \leq 6\,000 \text{ MHz}$ (see note 1)	-47 dBm
NOTE 1: The upper band measurement limit corresponds to the 5 th harmonic (5 150 MHz) as defined in ERC/Recommendation 74-01 [i.6], Table 1 plus a margin.	
NOTE 2: These limits are specified in ERC/Recommendation 74-01 [i.6], Table 2.	

4.2.3.7.3 Conformance

The conformance tests for this requirement are defined in clause 5.4.6.

4.2.3.8 Receiver dynamic range

4.2.3.8.1 Definition

The receiver dynamic range is the ability to receive a wanted signal across a range of signal levels while providing a pre-determined level of performance. The minimum signal level is defined as the receiver sensitivity specified in clause 4.2.3.6, which sets the maximum detectable distance in an A-SMGCS environment. The receiver dynamic range ensures continuous coverage up to near proximity, which determines the maximum signal level of continued coverage.

4.2.3.8.2 Limits

Receivers shall operate for signals with a carrier frequency of 1 090 MHz with a PD of not less than 90 % for signal levels that range from the defined sensitivity (-72 dBm) to a desired signal level of -2 dBm. This corresponds to a dynamic range of 70 dB.

4.2.3.8.3 Conformance

The conformance tests for this requirement are defined in clause 5.4.7.

5 Testing for compliance with technical requirements

5.1 Environmental conditions for testing

5.1.1 General requirements

Tests defined in the present document shall be carried out at representative points within the boundary limits of the operational environmental profile defined by its intended use, which, as a minimum, shall be that specified in the test conditions contained in the present document.

Where technical performance varies subject to environmental conditions, tests shall be carried out under a sufficient variety of environmental conditions as specified in the present document to give confidence of compliance for the affected technical requirements.

5.1.2 Test Conditions

5.1.2.1 Thermal Balance

Before measurements are made, the equipment shall have reached thermal balance in the test chamber. The thermal balance shall be checked by temperature measurements. When the equipment temperature is not changing more than 1 K per minute thermal balance is reached.

5.1.2.2 Normal Test Conditions

5.1.2.2.1 Temperature and humidity

For equipment intended to be operated indoors (partly temperature-controlled locations as defined in clause 4.2 of ETSI EN 300 019-1-3 [3]), the temperature and humidity conditions for tests shall be a combination of temperature and humidity as defined in ETSI EN 300 019-1-3 [3], clause 4.2, Figure 2 (Climatogram for class 3.2).

For equipment intended to be operated in an on-site equipment room (temperature-controlled locations as defined in clause 4.1 of ETSI EN 300 019-1-3 [3]), the temperature and humidity conditions for tests shall be a combination of temperature and humidity as defined in ETSI EN 300 019-1-3 [3], clause 4.1, Figure 1 (Climatogram for class 3.1).

For equipment intended to be operated outdoors (on-site outdoors locations), the temperature and humidity conditions for tests shall be a combination of temperature and humidity as defined in ETSI EN 300 019-1-4 [4], clause 4.1, Figure 1 (Climatogram for class 4.1).

The actual values during the tests shall be recorded in the test report.

5.1.2.2.2 Power supply

The power supply for testing shall be the nominal mains voltage. For the purpose of the present document, the nominal voltage shall be the declared voltage or any of the declared voltages for which the equipment was designed.

The actual values during the tests shall be recorded in the test report.

5.1.2.3 Extreme Test Conditions

5.1.2.3.1 Temperature and humidity

For equipment intended to be operated in an on-site equipment room (temperature-controlled locations as defined in clause 4.1 of ETSI EN 300 019-1-3 [3]), measurements shall be made at the lowest and highest temperatures as defined in ETSI EN 300 019-1-3 [3], clause 4.1, Figure 1 (Climatogram for class 3.1) and Table 1 (class 3.1, normal).

For equipment intended to be operated indoors (partly temperature-controlled locations as defined in clause 4.2 of ETSI EN 300 019-1-3 [3]), measurements shall be made at the lowest and highest temperatures as defined in ETSI EN 300 019-1-3 [3], clause 4.2, Figure 2 (Climatogram for class 3.2) and Table 1 (class 3.2).

For equipment intended to be operated outdoors (on-site outdoors locations), measurements shall be made at the lowest and highest temperatures as defined in ETSI EN 300 019-1-4 [4], clause 4.1, Figure 1 (Climatogram for class 4.1) and Table 1 (class 4.1).

The actual values during the tests shall be recorded in the test report.

A device capable of operating in more than one of these environments only needs to be tested for the most extreme environment.

5.1.2.3.2 Power supply

The power supply for testing shall be the nominal mains voltage $\pm 10\%$ (for AC power supply) or $\pm 20\%$ (for DC power supply). For the purpose of the present document, the nominal voltage shall be the declared voltage or any of the declared voltages for which the equipment was designed.

For an AC power supply, the maximum frequency offset of the nominal mains frequency shall be 2 Hz.

The actual values during the tests shall be recorded in the test report.

5.2 Test and General Conditions

5.2.1 Transmitter test signals

5.2.1.1 General Considerations

For the purposes of the present document a transmitter test signal is a modulated carrier generated by the EUT to facilitate a particular test. The EUT shall be capable of generating the following test signals:

- Test signal 1: Maximum duty cycle, short Mode S interrogations with all "0" data content - see clause 5.2.1.2.
- Test signal 2: Maximum duty cycle, short Mode S interrogations with all "1" data content - see clause 5.2.1.3.

Test signals may be generated autonomously by the EUT when configured for test mode, or by applying external commands or other stimulation.

5.2.1.2 Test signal 1

When test signal 1 is specified below, a signal shall be generated with the following characteristics:

- Transmission rate: Maximum constant rate such that the rated maximum duty cycle is not exceeded.
- Waveform: Short Mode S Interrogation as defined in ICAO Annex 10, Volume 4 [1], clause 3.1.2.1 and clause 3.1.2.11.4.
- Frequency: 1 030 MHz.
- Message content: All "0" (i.e. the minimum number of phase transitions).
- Amplitude: Maximum rated power level unless otherwise specified by the test.

NOTE: As an example, the calculation of the transmission rate for a rated maximum duty cycle of 1 % is as follows: the short Mode S interrogation contains the P1, P2 and P6 pulses as defined in ICAO Annex 10, Volume 4 [1], Figure 3-4. The cumulative time from the 50 % point of the rising edge of P1 to the 50 % point on the falling edge of P6 is 19,75 microseconds. The maximum transmission rate that does not exceed 1 % (i.e. 10 milliseconds per second of transmission time) is 506 Hz.

5.2.1.3 Test signal 2

When test signal 2 is specified below, a signal shall be generated with the following characteristics:

- Transmission rate: Maximum rate such that the rated maximum duty cycle is not exceeded.
- Waveform: Short Mode S Interrogation as defined in ICAO Annex 10, Volume 4 [1], clause 3.1.2.1 and clause 3.1.2.11.4.
- Frequency: 1 030 MHz.
- Message content: All "1" (i.e. the maximum number of phase transitions).
- Amplitude: Maximum rated power level unless otherwise specified by the test.

5.2.2 Simulated received signals

5.2.2.1 General Considerations

For the purposes of the present document a receiver test signal is an unmodulated or modulated carrier applied to the EUT to facilitate a particular test. The following test signals are used:

- Test signal 3: Modulated Mode S Extended Squitter message (desired signal) - see clause 5.2.2.2.
- Test signal 4: Modulated Mode S Extended Squitter message (undesired signal) - see clause 5.2.2.3.
- Test signal 5: Unmodulated CW signal (undesired signal) - see clause 5.2.2.4.

When multiple test signals are used in the same test, the frequency sources for each test signal shall be non-coherent.

The EUT shall be able to report each message received. The report shall include the complete Mode S message and the time of receipt at the receiver or the recording device with at least 10 millisecond resolution. Message reports from multilateration receivers can generally be collected using a computer and standard communication network analysis software.

5.2.2.2 Test signal 3

When test signal 3 is specified below, a signal shall be injected with the following characteristics:

- Transmission rate: 100 Hz, unless otherwise specified by the test.
- Waveform: Mode S Extended squitter as defined in ICAO Annex 10, Volume 4 [1], clause 3.1.2.2.
- Frequency: 1 090 MHz, unless otherwise specified by the test.
- Message content: Arbitrary data content with a known Aircraft Address and valid CRC.
- Amplitude: As specified by the test.
- Pulse on/off ratio: At least 40 dB.

EXAMPLE: 0x88234567125054D4C72CF4 is a valid DF-17 squitter with the Aircraft Address of "234567".

5.2.2.3 Test signal 4

When test signal 4 is specified below, a signal shall be injected with the following characteristics:

- Transmission rate: 6 000 Hz.
- Waveform: Mode S Extended squitter as defined in ICAO Annex 10, Volume 4 [1], clause 3.1.2.2.
- Frequency: As specified by the test.
- Message content: Arbitrary data content with a known Aircraft Address and valid CRC.
- Amplitude: As specified by the test.
- Pulse on/off ratio: At least 40 dB.

NOTE: The data content is distinct from Test signal 3.

EXAMPLE: 0x90BADBADC1123480101D00675B4B is a valid DF-18 squitter with the Aircraft Address of "BADBAD".

5.2.2.4 Test signal 5

When test signal 5 is specified below, a signal shall be injected with the following characteristics:

- Waveform: Continuous wave.
- Frequency: As specified by the test.
- Amplitude: As specified by the test.

5.3 Transmitter tests

5.3.1 Operating frequency and frequency error

5.3.1.1 Description

The purpose of this test is to establish that the transmitter is operating at the correct frequency and within the required frequency error.

5.3.1.2 Test conditions

The EUT shall be configured to generate test signal 1 as indicated in the procedure.

The measurement shall be performed according to clause 5.1.2.2 and clause 5.1.2.3.

The Spectrum Analyser shall have a frequency error (uncertainty) not exceeding 1 ppm.

NOTE: The test procedure ignores frequency excursions during the phase reversal. Further information is given in ICAO Annex 10, Volume IV [1], clause 3.1.2.1.1.

5.3.1.3 Method of measurement

The measurement shall use the connection to the EUT antenna interface.

Unless otherwise noted below, the spectrum analyser shall be configured to the following settings:

- Trigger level: As appropriate for input power and attenuation.
- Trace properties: Normal (e.g. not max hold).
- Sweep properties: As needed to capture a waveform without interruptions due to duty cycle.

The test setup shall be as in Figure 3.

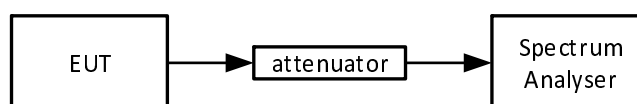

Figure 3: Test setup for operating frequency and frequency error

5.3.1.4 Measurement procedure

The test procedure shall be as follows:

- 1) Attach the EUT antenna port to the spectrum analyser as shown in Figure 3. The attenuation of the attenuator shall be such that the power level is in the working range of the spectrum analyser.
- 2) Configure the EUT to produce test signal 1 at the maximum rated power level and maximum duty cycle.
- 3) Set up the spectrum analyser with a resolution bandwidth of 30 kHz and a video bandwidth of 100 kHz.
- 4) Measure the frequency of the peak of the spectrum and verify that the measured value does not exceed the limits specified in clause 4.2.2.1.2.

5.3.2 Spectrum mask

5.3.2.1 Description

The in band and Out of Band domains are measured for compliance of the EUT with the spectrum mask.

5.3.2.2 Test conditions

The EUT shall be configured to generate test signal 1 and test signal 2 as indicated in the procedure.

The measurement shall be performed with the EUT operating at its maximum rated power level and minimum rated power level.

The measurement shall be performed according to clause 5.1.2.2 and clause 5.1.2.3.

The test shall be performed at the maximum rated duty cycle.

5.3.2.3 Method of measurement

The measurement shall use the connection to the EUT antenna interface.

Unless otherwise noted below, the spectrum analyser shall be configured to the following settings:

- Trigger level: As appropriate for input power and attenuation.
- Trace properties: Normal (e.g. not max hold).
- Sweep properties: As needed to capture a waveform without interruptions due to duty cycle.

The test setup shall be as in Figure 4.

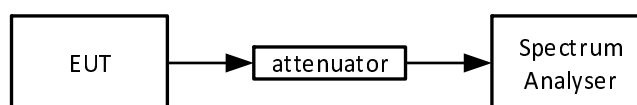

Figure 4: Test setup for spectrum mask

5.3.2.4 Measurement procedure

The test procedure shall be as follows:

- 1) Attach the EUT antenna port to the spectrum analyser with an attenuator such that the power level is in the working range of the spectrum analyser.
- 2) Configure the EUT to produce test signal 1 at the power level corresponding to the maximum rated power level and maximum duty cycle.
- 3) Set up the spectrum analyser with a resolution bandwidth of 1 MHz and a video bandwidth of 3 MHz.
- 4) Measure the spectrum from 905 MHz to 1 155 MHz and record the peak amplitude of the spectrum as a reference for 0 dBc.
- 5) Switch the EUT to produce test signal 2 at the same power level and duty cycle.
- 6) Measure the spectrum from 905 MHz to 1 155 MHz and verify that it does not exceed the spectrum mask limits defined in clause 4.2.2.2.2, taking into account the attenuation of the attenuator and the measured cable losses.
- 7) Repeat steps 1 to 6 setting the power level of the test signals (test signal 1 and test signal 2) to the minimum rated power level.

5.3.3 Residual Power Output

5.3.3.1 Description

The purpose of this test is to verify that the output power of the transmitter, when not in the active state, does not exceed the specified maximum.

5.3.3.2 Test conditions

The EUT shall be ready to transmit, but with no transmissions commanded externally and with no transmissions internally generated.

The measurement shall be performed according to clause 5.1.2.2.

5.3.3.3 Method of measurement

The measurement shall use the connection to the EUT antenna interface. All amplitudes shall be adjusted for cable loss.

The test setup shall be as in Figure 5.

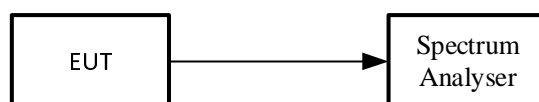

Figure 5: Test setup for residual power output

5.3.3.4 Measurement procedure

The test procedure shall be as follows:

- 1) Set the EUT so that it is ready to transmit, but no transmissions are generated.
- 2) Connect the spectrum analyser to the EUT antenna connector.

- 3) Taking into account the measured cable losses, verify that the residual power output does not exceed the limits specified in clause 4.2.2.3.2 when the spectrum analyser is tuned over the frequency range shown in Table 8 below.

All measurements shall be made with a reference bandwidth as shown in Table 8. The resolution bandwidth of the spectrum analyser shall be equal to the reference bandwidth.

Table 8: Reference bandwidths

Frequency Range	RBW	VBW
$9 \text{ kHz} \leq f < 150 \text{ kHz}$	1 kHz	3 kHz
$150 \text{ kHz} \leq f < 30 \text{ MHz}$	10 kHz	30 kHz
$30 \text{ MHz} \leq f \leq 1\,000 \text{ MHz}$	100 kHz	300 kHz
$1\,000 < f \leq 6\,000 \text{ MHz}$	1 MHz	3 MHz

NOTE 1: f is the measurement frequency.
 NOTE 2: 6 000 MHz corresponds to the 5th harmonic of the Interrogator transmitting at 1 030 MHz (5 150 MHz) plus a margin.
 NOTE 3: The reference bandwidths (RBW) are defined in ERC/Recommendation 74-01 [i.6].

5.3.4 Spurious emissions of transmitter in active mode

5.3.4.1 Description

The spurious domain is all frequencies apart from the channel on which the transmitter is intended to operate and the Out-of-Band domain.

5.3.4.2 Test conditions

Measurements shall be performed with the EUT operating at its maximum operating power level at the maximum duty cycle.

The measurement shall be performed according to clause 5.1.2.2 and clause 5.1.2.3.

5.3.4.3 Method of measurement

The measurement shall use the connection to the EUT antenna interface. All amplitudes shall be adjusted for the attenuation of the attenuator and cable losses.

5.3.4.4 Measurement Procedure

5.3.4.4.1 Part 1: Measurement of PEP and determination of spurious emission limit

The test setup shall be as in Figure 6.

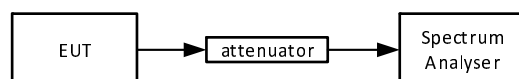

Figure 6: Test setup for the measurement of EUT PEP

The test procedure shall be as follows:

- 1) Connect the spectrum analyser to the EUT antenna connector with an attenuator such that the power level is in the acceptable range of the spectrum analyser.
- 2) Make the following settings in the spectrum analyser:
 - a) Set RBW to 1 MHz and VBW to 3 MHz (see Table 8).
 - b) Set the centre frequency to the frequency of the peak value of the spectrum.

- c) Set "frequency span" to zero.
 - d) Set the sweep time to a value equal or greater than the width of the selected pulse.
- 3) Taking into account the attenuation of the attenuator and the measured cable losses, measure the PEP by reading the power value at the crest of the envelope.

As described in clause 4.2.2.4.2, the limit of the spurious emission will be the less stringent between $43 + 10 \cdot \log(\text{PEP})$ and 60 dB below PEP, where PEP is the measured PEP.

5.3.4.4.2 Part 2: Spurious emission measurement procedure

The test setup shall be as in Figure 7.

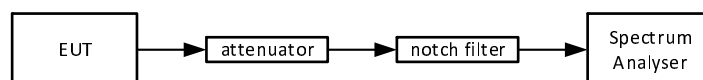

Figure 7: Test setup for spurious emissions of transmitter in active mode

The test procedure shall be as follows:

- 1) Connect the spectrum analyser to the EUT antenna connector with an attenuator such that the power level is in the acceptable range of the spectrum analyser. A 1 030 MHz notch filter is also necessary to avoid intermodulation effects that might be generated by the measurement equipment.
- 2) Tune the spectrum analyser subsequently to the frequency range shown in Table 9.
- 3) Taking into account the insertion losses of all components, verify that the power levels do not exceed the limit specified in clause 4.2.2.4.2 and determined as described in clause 5.3.4.4.1.

All measurements shall be made with a reference bandwidth as shown in Table 9. The resolution bandwidth of the spectrum analyser shall be equal to the reference bandwidth.

Table 9: Reference Bandwidths

Frequency Range	RBW	VBW
$9 \text{ kHz} \leq f < 150 \text{ kHz}$	1 kHz	3 kHz
$150 \text{ kHz} \leq f < 30 \text{ MHz}$	10 kHz	30 kHz
$30 \text{ MHz} \leq f < f_{m1}$	100 kHz	300 kHz
$f_{m2} < f \leq 6\,000 \text{ MHz}$	1 MHz	3 MHz

NOTE 1: f is the measurement frequency.
 NOTE 2: f_{m1} is the lower edge of the Out-of-Band Domain and equals $f_c - 125 \text{ MHz}$.
 NOTE 3: f_{m2} is the upper edge of the Out-of-Band Domain and equals $f_c + 125 \text{ MHz}$.
 NOTE 4: The Out-of-Band Domain is defined in clause 4.2.2.2.2 (Spectrum mask).
 NOTE 5: The reference bandwidths (RBW) are defined in ERC/Recommendation 74-01 [i.6].
 NOTE 6: 6 000 MHz corresponds to the 5th harmonic of the Interrogator transmitting at 1 030 MHz (5 150 MHz) plus a margin.

5.3.5 Transmitter intermodulation attenuation

5.3.5.1 Description

The purpose of this test is to establish that the transmitter does not generate unwanted signals in the presence of an external signal entering the transmitter via the antenna due to inter-modulation effects in the transmitter's non-linear elements.

5.3.5.2 Test Conditions

External test equipment will be used to create an interfering test signal with amplitudes and frequencies indicated in the procedure. External test equipment will be used for analysing the resulting transmitter output signal.

The interfering test signal shall be test signal 5 (see clause 5.2.2.4).

The measurement shall be performed according to clause 5.1.2.2.

5.3.5.3 Method of Measurement

The measurement shall use the connection to the EUT antenna interface.

The test setup shall be as in Figure 8.

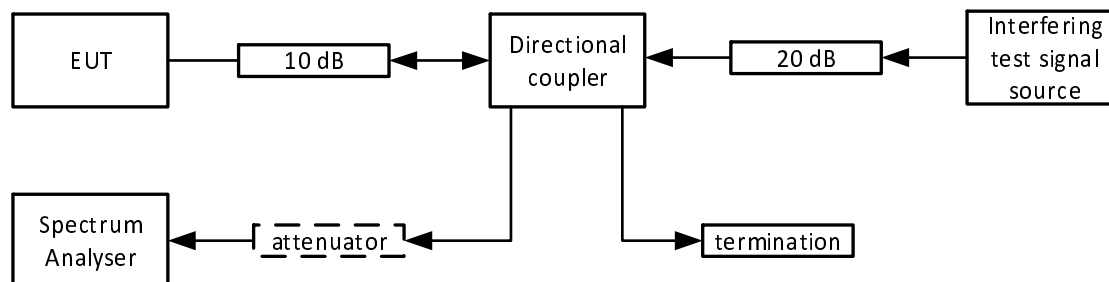

Figure 8: Test setup for transmitter intermodulation attenuation

The transmitter shall be connected to a 10 dB power attenuator and via a directional coupler to a spectrum analyser. An optional attenuator may be required between the directional coupler and the spectrum analyser to avoid overloading the spectrum analyser.

The interfering test signal source is connected to the other end of the directional coupler via a 20 dB power attenuator.

The interfering signal source shall be a signal generator and a linear power amplifier capable of delivering the same output power as the transmitter under test.

The directional coupler shall have an insertion loss of less than 1 dB, a bandwidth of at least 520 MHz and a directivity of more than 20 dB.

The EUT and the test signal source shall be physically separated by at least 2 meters to limit the influence of direct radiation.

5.3.5.4 Measurement Procedure

The test procedure shall be as follows:

- 1) The EUT shall be set to transmit test signal 2 and the spectrum analyser adjusted to give a maximum indication with a resolution bandwidth of 1 MHz and a scan range of $1\,030\text{ MHz} \pm 260\text{ MHz}$.
- 2) Record the peak of the spectrum as the carrier reference level.
- 3) The power output of the interfering test signal source shall be adjusted to 50 dBm, or the same as the peak of the EUT, whichever is lower (the required 30 dB attenuation is produced by the test setup).
- 4) The interfering signal frequency shall initially be set to 960 MHz and then increased in steps of 1 MHz up to 1 020 MHz.
- 5) The peak of the intermodulation component shall be measured by direct observation on the spectrum analyser and the ratio of the peak level (measured at step 2) to the power level of the largest third order intermodulation product shall be calculated.
- 6) Verify that the inter-modulation attenuation ratio does not exceed the limit specified in clause 4.2.2.5.2.
- 7) Repeat steps 5 and 6 with the interfering test signal source at a frequency starting at 1 040 MHz and then increased in steps of 1 MHz up to 1 215 MHz.

5.3.6 Transmitter time domain characteristics

5.3.6.1 Description

The purpose of this test is to establish that the transmitter produces well-formed Mode S interrogation waveforms that meet the required modulation thresholds.

5.3.6.2 Test Conditions

The measurement shall be performed according to clause 5.1.2.2 and clause 5.1.2.3.

5.3.6.3 Method of measurement

The measurement shall use the connection to the EUT antenna interface.

Pulse length measurements shall be determined by taking the time difference between the 50 % voltage amplitude point on the falling edge of the pulse to the 50 % voltage amplitude point on the rising edge of the pulse.

Pulse rise time measurements shall be determined by taking the time difference between the 90 % voltage amplitude to the 10 % voltage amplitude points on the rising edge of the pulse.

Pulse decay time measurements shall be determined by taking the time difference between the 10 % voltage amplitude to the 90 % voltage amplitude points on the falling edge of the pulse.

Pulse spacing measurements shall be determined by taking the time difference between the 50 % voltage amplitude point on the rising edge of the second pulse to the 50 % voltage amplitude point on the rising edge of the first pulse.

The phase reversal delay measurement shall be determined by taking the time difference between the minimum point of the phase transient amplitude and the 50 % voltage amplitude point on the rising edge of the P6 pulse.

The phase reversal width measurement shall be determined by taking the time difference between the 80 % voltage amplitude points at the phase transient.

The test setup shall be as in Figure 9.

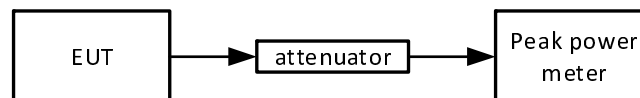

Figure 9: Test setup for time domain characteristics

5.3.6.4 Measurement procedure

The test procedure shall be as follows:

- 1) Attach the EUT antenna port to the peak power meter with an attenuator such that the power level is in the working range of the power meter.
- 2) Configure the EUT to produce test signal 1 at the power level corresponding to the rated peak power level.
- 3) Capture the waveform on the peak power meter.
- 4) Verify that each of the pulse shape parameters is within the thresholds specified in clause 4.2.2.6.2.
- 5) Verify that each of the pulse spacing parameters is within the thresholds specified in clause 4.2.2.6.2.

5.4 Receiver Tests

5.4.1 Sensitivity and Sensitivity variation over the operating frequency range

5.4.1.1 Description

The purpose of this test is to establish that the receiver is operating at the intended frequency and is able to tolerate a certain degree of frequency offset. The receiver sensitivity is also established.

5.4.1.2 Test conditions

External test equipment shall be used to stimulate the EUT with test signal 3 at the amplitudes indicated in the procedure. External test equipment shall be used to collect the reception reports for each injected message.

The measurement shall be performed according to clauses 5.1.2.2 and 5.1.2.3.

5.4.1.3 Method of measurement

The test waveform shall be injected into the EUT antenna interface. All amplitudes shall be adjusted for cable losses.

The test setup shall be as in Figure 10.



Figure 10: Test setup for sensitivity over operating frequency

5.4.1.4 Measurement procedure

The test procedure shall be as follows:

- 1) Configure the EUT to receive and report messages for recording.
- 2) Verify that no message reports are being generated.
- 3) Configure the signal generator to produce test signal 3 at the operating frequency and with the amplitude specified in clause 4.2.3.6.2 (-72 dBm).
- 4) Configure the Network Traffic Analyser to record message reports.
- 5) Inject 1 000 messages per second for at least 100 seconds.
- 6) Review the recorded reports to count the number of reports which match the expected message content.
- 7) Divide the number of successfully received messages by the expected number of input messages (i.e. elapsed time multiplied by message rate) and verify that the required PD as defined in clause 4.2.3.6.2 (at least 90 %) is achieved.
- 8) Decrease the signal level in 1 dB steps until the probability of detection is no longer achieved. The lowest amplitude at which the required PD (clause 4.2.3.6.2) is achieved will be used as the reference signal level (i.e. the reference sensitivity) for the following steps and subsequent tests.
- 9) Change the signal level of test signal 3 to the reference sensitivity measured in step 8 plus the degradation level specified in clause 4.2.3.1.2 (i.e. add 3 dB).
- 10) Repeat steps 4 to 7 with the signal generator configured to produce test signal 3 to the operating frequency plus 1 MHz as specified in clause 4.2.3.1.2.

- 11) Repeat steps 4 to 7 with the signal generator configured to produce test signal 3 to the operating frequency minus 1 MHz as specified in clause 4.2.3.1.2.

5.4.2 RF selectivity and spurious response rejection

5.4.2.1 Description

The purpose of this test is to establish the selectivity of the receiver by measuring the rate of detection of properly formed messages injected outside of the intended operating frequency. The amplitude of injected messages is adjusted to verify that an appropriate number of messages are rejected.

5.4.2.2 Test conditions

External test equipment shall be used to stimulate the EUT with test signal 3 at the amplitudes and frequencies indicated in the procedure. External test equipment shall be used to collect the reception reports for each injected message.

The measurement shall be performed according to clause 5.1.2.2.

5.4.2.3 Method of measurement

The test waveform shall be injected into the EUT antenna interface. The message receipt reports shall be collected and the average rate of message receipt shall be calculated.

The test setup shall be as in Figure 11.



Figure 11: Test setup for RF selectivity

5.4.2.4 Measurement procedure

The test procedure shall be as follows:

- 1) Configure the EUT to receive and report messages for recording.
- 2) Configure the signal generator to produce test signal 3 a rate of 1 000 messages per second, -70 dBm, 1 090 MHz.
- 3) Configure the Network Traffic Analyser to record message reports for a period of at least 10 seconds.
- 4) Evaluate the 1 090 MHz Probability of Detection ($P_d / 1\ 090$). Divide the number of successfully received messages by the expected number of input messages (i.e. elapsed time multiplied by message rate).
- 5) Change the signal generator power to -67 dBm, and inject in the EUT test signal 3 at the following frequencies:
 1 102,5 MHz, 1 104 MHz, 1 105 MHz, 1 106 MHz, 1 107 MHz, 1 108 MHz,
 1 077,5 MHz, 1 076 MHz, 1 075 MHz, 1 074 MHz, 1 073 MHz, 1 072 MHz
- 6) For each of the frequencies at step 5, evaluate the Probability of Detection of the injected scenario ($P_d\ offset$) at the injected amplitude.
- 7) Change the signal generator power to -50 dBm, and inject in the EUT test signal 3 at the following frequencies:
 1 109 MHz to 1 118 MHz at 1 MHz steps
 1 071 MHz to 1 062 MHz at 1 MHz steps

- 8) For each of the frequencies at step 7, evaluate the Probability of Detection of the injected scenario ($P_d \text{ offset}$) at the injected amplitude.
- 9) Change the signal generator power to -30 dBm, and inject in the EUT test signal 3 at the following frequencies:
 - 1 119 MHz to 1 135 MHz at 1 MHz steps
 - 1 061 MHz to 1 045 MHz at 1 MHz steps
- 10) For each of the frequencies at step 7, evaluate the Probability of Detection of the injected scenario ($P_d \text{ offset}$) at the injected amplitude.
- 11) Change the signal generator power to -10 dBm, and inject in the EUT test signal 3 at the following frequencies:
 - 1 136 MHz to 1 168 MHz at 1 MHz steps
 - 1 044 MHz to 1 012 MHz at 1 MHz steps
- 12) For each of the frequencies at step 11, evaluate the Probability of Detection of the injected scenario ($P_d \text{ offset}$) at the injected amplitude.
- 13) Verify that the test results are in accordance with the requirements specified in clause 4.2.3.2.2 ($P_d \text{ offset} \leq P_d 1 090$).

5.4.3 Inter-modulation response rejection

5.4.3.1 Description

The purpose of this test is to establish that inter-modulation caused by two unwanted Out-of-Band signals does not degrade the reception probability when their signal level is below the specified limit.

5.4.3.2 Test conditions

The measurement shall be performed according to clause 5.1.2.2.

5.4.3.3 Method of measurement

The test waveform shall be injected into the EUT antenna interface.

The test setup shall be as in Figure 12.

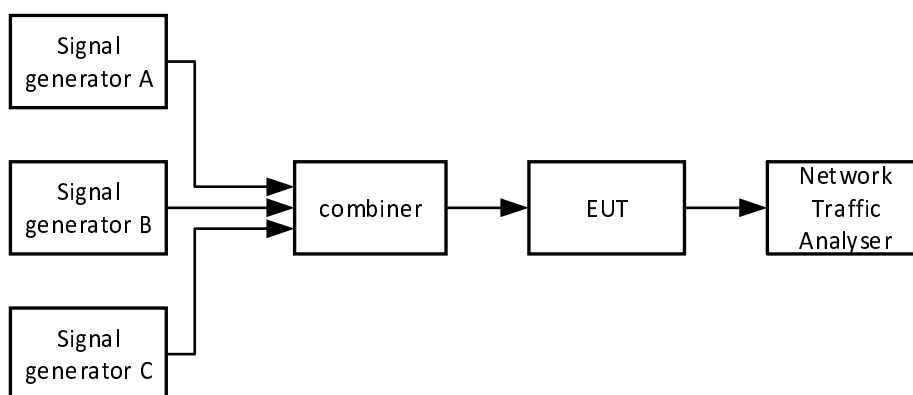

Figure 12: Test setup for intermodulation response rejection

5.4.3.4 Measurement procedure

The measurement procedure shall be as follows:

- 1) Three signal generators, A, B and C, shall be connected to the receiver via a combiner:
 - The wanted signal, provided by signal generator A, shall be at the nominal frequency of the receiver and shall produce test signal 3.
 - The first unwanted signal, provided by signal generator B, shall be unmodulated and adjusted to a frequency f_1 at 20 MHz above the nominal frequency of the receiver.
 - The second unwanted signal, provided by signal generator C, shall be test signal 4 and adjusted to a frequency f_2 at 40 MHz above the nominal frequency of the receiver.
- 2) Initially, signal generators B and C (unwanted signals) shall be switched off (maintaining the output impedance):
 - The level of the wanted signal from generator A shall be adjusted to the level which is 20 dB above the reference sensitivity measured in the test specified in clause 5.4.1 (Sensitivity variation over the operating frequency range).
- 3) Record the PD of the wanted signal.
- 4) Signal generators B and C shall then be switched on and set to a level 40 dB above the reference sensitivity measured in the test specified in clause 5.4.1.
- 5) Record the PD of the wanted signal.
- 6) Verify that the PD from step 5 is degraded by no more than the limit specified in clause 4.2.3.3.2.
- 7) The measurement shall be repeated with the unwanted signal generator B at the frequency 20 MHz below that of the wanted signal and the frequency of the unwanted signal generator C at the frequency 40 MHz below that of the wanted signal.
- 8) Repeat the test steps 1 to 7 with at least the 4 frequencies below fulfilling $f_c = 2 \times f_1 - f_2$ (with an offset of f_1 and f_2 in the range of +20 MHz to +78 MHz and -20 MHz to -78 MHz):
 - $f_1 = 1\ 051$, $f_2 = 1\ 012$ ($f_2 = 1\ 090$ MHz - 78 MHz)
 - $f_1 = 1\ 060$, $f_2 = 1\ 030$ ($f_2 = 1\ 090$ MHz - 60 MHz)
 - $f_1 = 1\ 108$, $f_2 = 1\ 126$ ($f_2 = 1\ 090$ MHz + 36 MHz)
 - $f_1 = 1\ 129$, $f_2 = 1\ 168$ ($f_2 = 1\ 090$ MHz + 78 MHz)

NOTE: The frequency $f_2 = 1\ 030$ MHz is included since it corresponds to another interrogator.

5.4.4 Co-channel rejection

5.4.4.1 Description

This test verifies that the receiver's reception probability is not degraded in the presence of an unwanted modulated signal at the same frequency when its signal level does not exceed the limit specified in clause 4.2.3.4.2.

5.4.4.2 Test conditions

The measurement shall be performed according to clause 5.1.2.2.

5.4.4.3 Method of measurement

The test waveform shall be injected into the EUT antenna interface.

The test setup shall be as in Figure 13.

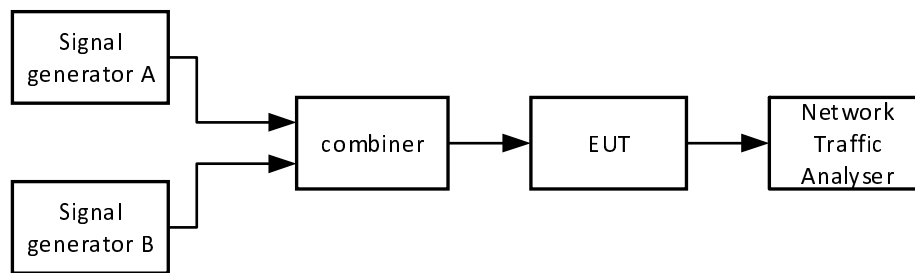

Figure 13: Test setup for co-channel rejection

5.4.4.4 Measurement procedure

The test procedure shall be as follows:

- 1) Two signal generators A and B shall be connected to the receiver via a combiner. The wanted signal, represented by signal generator A, shall be at the nominal frequency of the receiver and shall be test signal 3.
- 2) The unwanted signal, represented by signal generator B, shall be at the nominal frequency of the receiver and shall be a test signal 4.
- 3) Both input signals shall be at the nominal frequency of the receiver under test.
- 4) Initially the unwanted signal shall be switched off (maintaining its output impedance).
- 5) The level of the wanted signal from generator A shall be adjusted to a level which is 20 dB above the reference sensitivity measured in the test specified in clause 5.4.1 (Sensitivity variation over the operating frequency range).
- 6) Record the PD for the wanted signal.
- 7) The unwanted signal from generator B shall then be switched on and its level shall be adjusted to 12 dB below the wanted signal as referenced at the input of the receiver under test.
- 8) Record the PD for the wanted signal.
- 9) Verify that the PD from step 8 is degraded by no more than the limit specified in clause 4.2.3.4.2.
- 10) The measurement shall be repeated for displacements of the unwanted signal at 1 088,7 MHz and 1 091,3 MHz.

NOTE: $\pm 1,3$ MHz is the 3-dB width from ICAO Annex 10, Volume 4 [1], Figure 3-5. It is reasonable to expect the bandwidth of a real co-channel signal to be this wide. For testing, the signal generator bandwidth might be sufficiently narrow that $\pm 1,3$ MHz is not actually verified. Therefore, the test is repeated at frequencies 1 088,7 and 1 091,3 MHz.

5.4.5 Blocking

5.4.5.1 Description

With this test it will be verified that a single unwanted Out-of-Band signal cannot degrade the reception probability when its signal level is below the limit specified in clause 4.2.3.5.2.

5.4.5.2 Test conditions

The measurement shall be performed according to clause 5.1.2.2.

5.4.5.3 Method of measurement

The test waveform shall be injected into the EUT antenna interface.

The test setup shall be as in Figure 14.

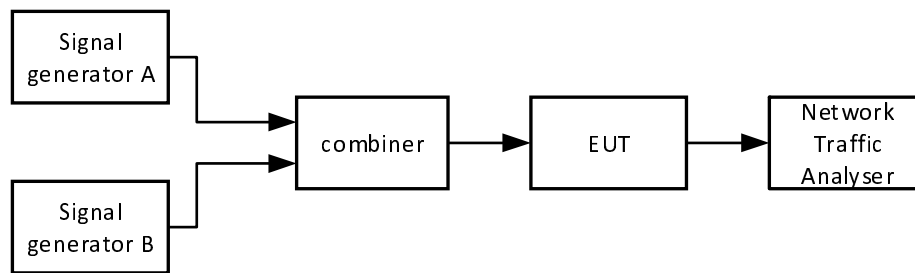

Figure 14: Test setup for blocking

5.4.5.4 Measurement procedure

The test procedure shall be as follows:

- 1) Two signal generators A and B shall be connected to the receiver via a combiner.
- 2) The wanted signal, represented by signal generator A, shall be at the nominal frequency of the receiver and shall be a test signal 3.
- 3) The unwanted signal, provided by signal generator B, shall be continuous wave and at the minimum frequency specified in clause 4.2.3.5.2 (i.e. 1 090 MHz - 78 MHz = 1 012 MHz).
- 4) Initially the unwanted signal shall be switched off.
- 5) The level of the wanted signal from generator A shall be adjusted to a level which is 6 dB above the reference sensitivity measured in the test described in clause 5.4.1.
- 6) Record the PD of the wanted signal.
- 7) The unwanted signal shall then be switched on and its level shall be adjusted to the level specified in clause 4.2.3.5.2.
- 8) Record the PD of the wanted signal.
- 9) Verify that the PD from step 8 is degraded by no more than the limit specified in clause 4.2.3.5.2 (i.e. 5 %).
- 10) The measurement shall be repeated for frequencies throughout the range defined in clause 4.2.3.5.2 at 1 MHz steps.

5.4.6 Receiver spurious emissions

5.4.6.1 Description

For receivers, or EUT in receive mode, the spurious domain is all frequencies.

5.4.6.2 Test conditions

The measurement shall be performed according to clause 5.1.2.2.

5.4.6.3 Method of measurement

The test waveform shall be injected into the EUT antenna interface. All amplitudes shall be adjusted for cable loss.

The test setup shall be as in Figure 15.

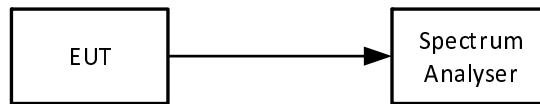

Figure 15: Test setup for receiver spurious emissions

5.4.6.4 Measurement Procedure

The test procedure shall be as follows:

- 1) Connect the spectrum analyser to the EUT antenna connector.
- 2) Tune the spectrum analyser subsequently to the frequency range shown in Table 10.
- 3) Note the detected power levels at the spectrum analyser.
- 4) Taking into account the measured cable losses, verify that the power level does not exceed the limits specified in clause 4.2.3.7.2.

All measurements shall be made with a reference bandwidth as shown in Table 10.

Table 10: Reference Bandwidths

Frequency Range	RBW	VBW
$9 \text{ kHz} \leq f < 150 \text{ kHz}$	1 kHz	3 kHz
$150 \text{ kHz} \leq f < 30 \text{ MHz}$	10 kHz	30 kHz
$30 \text{ MHz} \leq f \leq 1 \text{ GHz}$	100 kHz	300 kHz
$1 \text{ GHz} < f \leq 6\,000 \text{ MHz}$	1 MHz	3 MHz

NOTE 1: f is the measurement frequency.
 NOTE 2: The Reference BandWidths (RBW) are defined in ERC/Recommendation 74-01 [i.6].

5.4.7 Receiver Dynamic Range

5.4.7.1 Description

The purpose of this test is to establish that the receiver is able to correctly decode input signals with amplitudes across the dynamic range. A -72 dBm sensitivity is established, and detectability is then verified through the dynamic range up to the maximum required amplitude.

5.4.7.2 Test Conditions

External test equipment shall be used to stimulate the EUT with test signal 3 at the amplitudes indicated in the procedure. External test equipment shall be used to collect the reception reports for each injected message.

The measurement shall be performed according to clauses 5.1.2.2 and 5.1.2.3.

5.4.7.3 Method of measurement

The test waveform shall be injected into the EUT antenna interface. All amplitudes shall be adjusted for cable losses. The message receipt reports shall be collected and the average rate of message receipt shall be calculated at each amplitude.

The test setup shall be as in Figure 16.

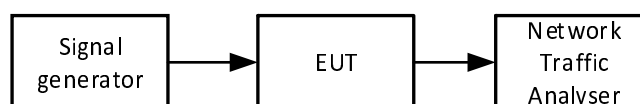

Figure 16: Test setup for receiver dynamic range

5.4.7.4 Measurement procedure

The test procedure shall be as follows:

- 1) Configure the EUT to receive and report messages for recording.
- 2) Configure the Network Traffic Analyser to record message reports.
- 3) Verify that no message reports are being generated.
- 4) Configure the signal generator to produce test signal 3 at the amplitude specified in clause 4.2.3.6.2 (i.e. the sensitivity level). Inject at least 1 000 messages per second for at least 100 seconds.
- 5) Review the recorded reports to count the number of reports which match the expected message content.
- 6) Divide the number of successfully received messages by the expected number of input messages (i.e. elapsed time multiplied by message rate) and verify that the required PD (clause 4.2.3.8.2) is achieved.
- 7) Repeat the test 7 times increasing the signal level of the test signal 3 by 10 dB each time (i.e. -62 dBm, -52 dBm, -42 dBm, -32 dBm, -22 dBm, -12 dBm, -2 dBm) and verify that the probability of detection is no less than 90 %.

Annex A (informative): Relationship between the present document and the essential requirements of Directive 2014/53/EU

The present document has been prepared under the Commission's standardisation request C(2015) 5376 final [i.3] to provide one voluntary means of conforming to the essential requirements of Directive 2014/53/EU on the harmonisation of the laws of the Member States relating to the making available on the market of radio equipment and repealing Directive 1999/5/EC [i.1].

Once the present document is cited in the Official Journal of the European Union under that Directive, compliance with the normative clauses of the present document given in Table A.1 confers, within the limits of the scope of the present document, a presumption of conformity with the corresponding essential requirements of that Directive, and associated EFTA regulations.

Table A.1: Relationship between the present document and the essential requirements of Directive 2014/53/EU

Harmonised Standard ETSI EN 303 213-5-1					
Requirement				Requirement Conditionality	
No	Description	Essential requirements of Directive	Clause(s) of the present document	U/C	Condition
1	Transmitter operating frequency and frequency error	3.2	4.2.2.1	C	Equipment with the interrogator function
2	Transmitter spectrum mask	3.2	4.2.2.2	C	Equipment with the interrogator function
3	Transmitter residual power output	3.2	4.2.2.3	C	Equipment with the interrogator function
4	Spurious emissions of transmitter in active mode	3.2	4.2.2.4	C	Equipment with the interrogator function
5	Transmitter Intermodulation Attenuation	3.2	4.2.2.5	C	Equipment with the interrogator function
6	Transmitter time domain characteristics	3.2	4.2.2.6	C	Equipment with the interrogator function
7	Receiver sensitivity variation over the operating frequency range	3.2	4.2.3.1	C	Equipment with the receiver function
8	Receiver RF selectivity and spurious response rejection	3.2	4.2.3.2	C	Equipment with the receiver function
9	Receiver inter-modulation response rejection	3.2	4.2.3.3	C	Equipment with the receiver function
10	Receiver Co-channel rejection	3.2	4.2.3.4	C	Equipment with the receiver function
11	Receiver Blocking	3.2	4.2.3.5	C	Equipment with the receiver function
12	Receiver Sensitivity	3.2	4.2.3.6	C	Equipment with the receiver function
13	Receiver spurious emissions	3.2	4.2.3.7	C	Equipment with the receiver function
14	Receiver dynamic range	3.2	4.2.3.8	C	Equipment with the receiver function

Key to columns:

Requirement:

No A unique identifier for one row of the table which may be used to identify a requirement.

Description A textual reference to the requirement.

Essential requirements of Directive

Identification of article(s) defining the requirement in the Directive.

Clause(s) of the present document

Identification of clause(s) defining the requirement in the present document unless another document is referenced explicitly.

Requirement Conditionality:

U/C Indicates whether the requirement is unconditionally applicable (U) or is conditional upon the manufacturer's claimed functionality of the equipment (C).

Condition Explains the conditions when the requirement is or is not applicable for a requirement which is classified "conditional".

Presumption of conformity stays valid only as long as a reference to the present document is maintained in the list published in the Official Journal of the European Union. Users of the present document should consult frequently the latest list published in the Official Journal of the European Union.

Other Union legislation may be applicable to the product(s) falling within the scope of the present document.

Annex B (informative): Maximum measurement uncertainty

The measurements described in the present document are based on the following assumptions:

- the measured value related to the corresponding limit is used to decide whether an equipment meets the requirements of the present document;
- the value of the measurement uncertainty for the measurement of each parameter is included in the test report.

Table B.1 shows the recommended values for the maximum measurement uncertainty figures.

Table B.1: Maximum measurement uncertainty

Parameter	Uncertainty
Environment measurements	
Temperature	1 °C
Relative humidity	5 %
Mains Supply Voltage	±2 %
Transmitter measurements	
Frequency	±1 ppm
Transmitter power	±1,5 dB
Out-of-Band emissions	±4 dB
Spurious emissions	±4 dB
Transmitter time domain characteristics	1 ns
Transmitter Intermodulation attenuation	±1 dB
Receiver measurements	
Receiver Selectivity and spurious response rejection	±1 dB
Receiver Sensitivity and flatness	±1 dB
Receiver blocking	±1 dB
Intermodulation response rejection	±1 dB
Receiver co-channel rejection	±1 dB
Receiver Spurious emissions	±4 dB

Annex C (informative): Checklist

This annex provides a traceability of the technical parameters for article 3.2 of Directive 2014/53/EU [i.1] defined in ETSI EG 203 336 [i.5] with the technical requirements for conformance defined in clause 4 of the present document.

If a technical parameter for article 3.2 of Directive 2014/53/EU [i.1] defined in ETSI EG 203 336 [i.5] has not been included in the present document, an explanation is provided.

An explanation is also provided whenever a technical parameter defined in ETSI EG 203 336 [i.5] is covered by an alternative technical requirement.

Table C.1: Checklist

Technical Parameters defined in ETSI EG 203 336 [i.5]	Clauses of the present document	Comments
Transmitter Parameters		
Transmit power limits and accuracy	NA	The transmitter power is subject to national regulation and therefore no limit can be specified.
Transmitter Spectrum mask	4.2.2.2	
Transmitter Frequency stability	4.2.2.1	
Transmitter Intermodulation attenuation	4.2.2.5	
Unwanted emissions (OOB and spurious domains)	4.2.2.2	
	4.2.2.3	
	4.2.2.4	
Transmitter Time domain characteristics (e.g. the duty cycle, turn-on and turn-off, frequency hopping cycle, dynamic changes of modulation scheme and others)	4.2.2.6	
Transmitter Transients	4.2.2.2	This requirement is covered by the spectrum mask.
Receiver Parameters		
Receiver sensitivity	4.2.3.1	
	4.2.3.6	
Receiver co-channel rejection	4.2.3.4	
Adjacent band/channel selectivity	4.2.3.2	
Spurious response rejection	4.2.3.2	
Receiver blocking	4.2.3.5	
Receiver radio-frequency intermodulation	4.2.3.3	
Receiver unwanted emissions in the spurious domain	4.2.3.7	
Receiver dynamic range	4.2.3.8	
Reciprocal mixing	4.2.3.2	Reciprocal mixing is covered by the Selectivity and the receiver blocking. Moreover TX and RX frequencies are fixed and so image frequencies are evaluated as part of the intermodulation rejection.
	4.2.3.5	

Annex D (informative): Bibliography

- ITU Recommendation M.1177-4 (2011): "Techniques for measurement of unwanted emissions of radar equipment".
- ITU Recommendation SM.329-12 (2012): "Unwanted emissions in the spurious domain".
- ITU Recommendation ITU-R SM.1541-6 (08/2015): "Unwanted emissions in the out-of-band domain".
- EUROCAE ED-73E (2011): "MOPS for Secondary Surveillance Radar Mode S Transponders".
- EUROCAE ED-129B (March 2016): "Technical Specification for a 1090 MHz Extended Squitter ADS-B Ground System".

Annex E (informative): Change history

Version	Information about changes
1.1.1	First published version.
2.0.0	<p>The following technical requirements have been added:</p> <ul style="list-style-type: none">• Transmitter Intermodulation Attenuation• Transmitter time domain characteristics• Receiver dynamic range <p>The RF selectivity and spurious response rejection test is done in an extended frequency range. The environmental profile has been included. The residual power test has been updated. VBW added. General improvement of the text and editorial corrections.</p>

History

Document history		
V1.1.1	March 2020	Publication
V2.0.0	July 2023	EN Approval Procedure AP 20231003: 2023-07-05 to 2023-10-03
V2.1.1	October 2023	Publication